



Jan Nowak[®]

Steel Cabinets

Catalog 2024

OFFICE FURNITURE 5

ALEX.....	6
AMELIA.....	8
BEATA.....	10
DAMIAN.....	12
DANIEL.....	14
EDMUND.....	16
EWA.....	18
FILIP.....	20
FILIP II.....	22
JAN.....	24
JAN H.....	26
JAN II.....	28
KEVIN.....	30
KUBA.....	32
LENA.....	34
MAGDA.....	36
SARA 3.....	38
SARA 4.....	40
SARA 5.....	42
TOMASZ.....	44
WIOLA.....	46

SOCIAL FURNITURE 49

BARTEK.....	50
BARTUŚ.....	52
BORYS.....	54
DAWID.....	56
IGOR.....	58
IGOREK.....	60
JULIA.....	62
KACPER.....	64
KACPER II.....	66
KACPER II PRO.....	68
KAROL.....	70
MARCIN.....	72
OLA.....	74
OLIVER.....	76
ROBERT.....	78

WORKSHOP FURNITURE 81

BEN.....	82
BRUNO.....	84
DAREK.....	86
ERIC.....	88
FRANK.....	90
HENRY.....	92
HUGO.....	94
JOE.....	96
LEO.....	98
LOGAN.....	100
MARIUSZ.....	102
PAULA.....	104
SAM.....	106
STEVE.....	108
SZYMON.....	110
INDEX TABLE.....	112
NOTES.....	115



Office Furniture



Model: ALEX



Colours:



ALEX is a slim, compact yet very roomy file cabinet. This versatile model is an ideal solution for small offices and offices that lack storage space. The narrow width of the ALEX closet (only 45cm) makes this piece of furniture very adaptable, yet extremely roomy.

Description

Size:	1850x450x400mm	Steel thickness:	0,6 mm
Weight of the cabinet:	28,50kg	Warranty:	6 years
Material:	Powder coated steel	Certificate:	PZH
Package dimensions:	194,5x54,5x11 cm		

For which rooms:



Offices, accounting offices, law offices, home offices



Medical facilities, doctors' offices, beauty salons



Schools, kindergartens, universities, housing cooperatives



Workshops, warehouses, garages

Advantages of ALEX cabinet:

- Narrow, but very capacious - with a width of 45cm it can accommodate up to 25 binders;
- The size of the cabinet is its great advantage - there will be a place for it in any room!
- Equipped with 4 extremely durable shelves - their total load capacity is up to 200kg!
- Possibility to adjust the inside of the cabinet to your own needs, thanks to the possibility to adjust the height of the shelves every 25mm;
- 3-point bolted lock in as many as three places locks the door and prevents unauthorized people from opening it;
- The cabinet meets the requirements of GDPR 2018 - ensures the security of stored documents;
- Holes on the back wall of the cabinet that allow you to attach it permanently to the wall of the room, making its use safer;
- Easily blends in with other models from the Jan Nowak offer;
- Simple, quick, self-assembly.

Main features:

- ✓ Narrow, capacious, compact and adjustable
- ↑ ↓ Adjustable shelves
- ✦ High quality steel = exceptional durability
- 🔒 3-point lock

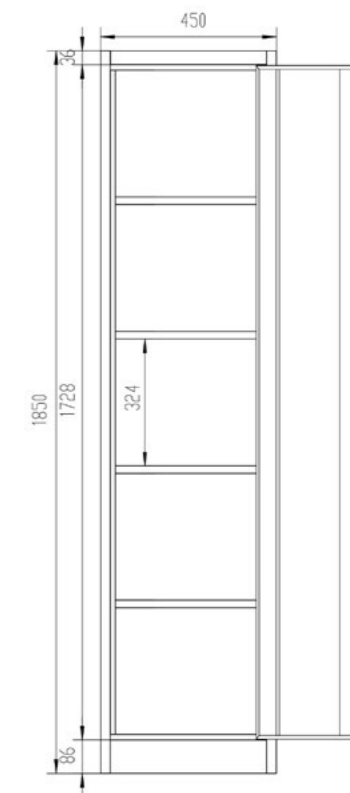
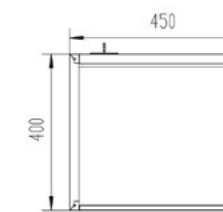

Model: AMELIA



Colours:



AMELIA is a stylish, glazed multi-purpose cabinet that is great for storing medicines, documents, small appliances and even tableware. The glazed door gives it lightness and facilitates quick access to the contents on each shelf. The interior of the cabinet can be adjusted to suit your needs and the size of the items stored in it, the security of which is taken care of by a solid 3-point bolted lock.

Description

Size:	1850x900x400mm	Steel thickness:	0,6 mm
Cabinet weight:	48,50kg	Warranty:	6 years
Material:	Powder coated steel	Certificate:	PZH
Package dimensions:	194x100x8 cm		

For which rooms:



Offices, schools, law offices



Hospitals, clinics



Medical offices, school nurse's offices



Beauty salons



Social rooms, employee canteens

Advantages of AMELIA cabinet:

- Multi-purpose - will work well for storing medicines, documents, medical equipment, dishes, etc.;
- Classically stylish: simple, elegant design, fashionable colors, glass door;
- 4 incredibly durable shelves - can withstand a load of up to 50kg. This gives you the ability to store up to 200kg in total in the cabinet;
- Adjustable shelves in 25mm increments, allowing you to customize the cabinet to your own needs;
- Double-leaf doors are secured with a 3-point interlocking lock, which gives exceptional security;
- The model is adapted to the regulations of GDPR 2018;
- The cabinet can be attached to the wall, and thus improve the security of daily use in the office or study;
- Simple, fast, self-assembly.

Main features:



Modern, stylish design



Glazed door allows easy orientation



3-point lock ensures security of stored items



Shelves can be adjusted in height



High capacity and durability (50 binders / 200kg)

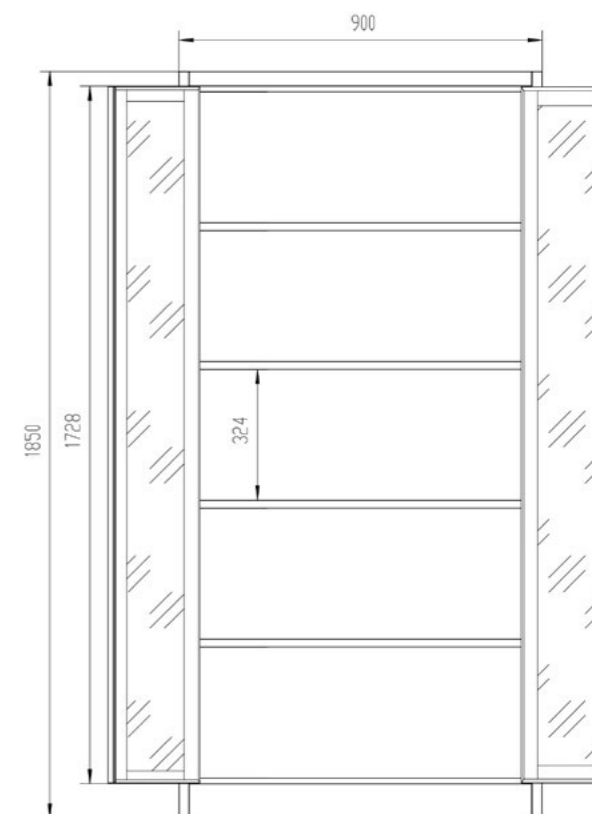
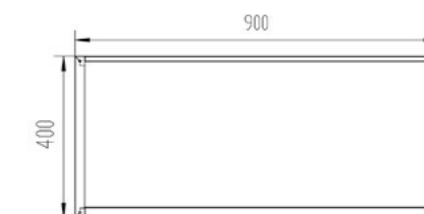

Model: BEATA



BEATA is one of the smallest models of cabinets in the Jan Nowak range. This is a piece of furniture that is perfect for offices and medical offices, but not only. This cabinet is only 90cm wide and it can store as many as 25 binders, a dozen containers or small tools or devices. In addition, the wide top of the BEATA cabinet located at a height of 90cm gives a large surface that can be used to place documents, office equipment (such as a printer), flowers or other decorations on it.

Description

Size:	900x925x400mm	Steel thickness:	0,6 mm
Cabinet weight:	24kg	Warranty:	6 years
Material:	Powder coated steel	Certificate:	PZH
Package dimensions:	101,5x99,5x9,5 cm		

Colours:



For which rooms:



Offices, secretariats



Doctors' offices, clinics, beauty parlors



Schools



Logistic companies, transport companies



Car workshops, manufacturing plants, garages

Advantages of BEATA cabinet:

- Wide, sturdy top allows you to use it, for example, under the printer or as a place to set decorations;
- 3-point lock ensures the security of the documents stored in it (meets the requirements of GDPR 2018);
- Two wide and adjustable shelves, the height of which can be adjusted to specific needs and the dimensions of the items or documents stored in it;
- Each shelf can lift up to 50 kg;
- Thanks to the thick, resistant to mechanical damage steel, the cabinet will provide many years of use;
- The cabinet can be easily cleaned and disinfected;
- Quick installation.

Main features:



Top - various possibilities of its use



High load capacity of shelves - 50 kg



Large capacity with small size



3-point lock



High quality steel, exceptional durability

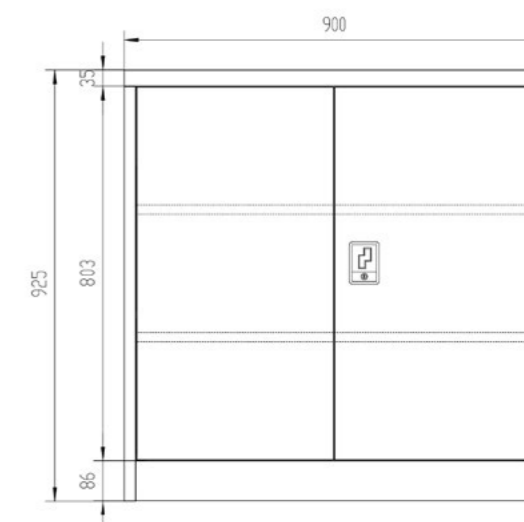

Model: DAMIAN



Colours:



DAMIAN is a closet model, which is distinguished by its modern design and sliding doors in the form of a roller shutter. Thanks to this solution, the closet can be located in a place where a piece of furniture with traditionally opened doors would not work. The closet door is closed with a bolted, three-point lock, which ensures the safety of the documents stored in it. DAMIAN will be perfect for office spaces where documents need to be kept under lock and key.

Description

Size:	1850x900x450mm
Cabinet weight:	45 kg
Package dimensions:	193x55,5x14 cm
Material:	Powder coated steel

Steel thickness:	0,6 mm
Warranty:	6 years
Certificate:	PZH

For which rooms:



Offices, secretariats



Schools



Treatment rooms, beauty salons



Car workshops, production plants

Advantages of DAMIAN closet:

- Sliding doors in the form of roller blinds will allow access to the contents of the cabinet even in very narrow rooms;
- A 3-point lock ensures the security of the documents stored in it (meets the requirements of GDPR 2018) - the cabinet is made of durable, powder-coated steel 0.6 mm thick, which makes it extremely resistant to mechanical damage;
- The cabinet has 4 very durable adjustable shelves, where the load capacity of each shelf is up to 50 kg;
- Closet available in many color variants so that it can be freely composed with other closets in the color of the body from the Jan Nowak offer;
- Holes in the back wall allow it to be attached to the wall, and thus increase security in the room;
- Simple, quick, self-assembly.

Main features:



Sliding doors



High load capacity of shelves - up to 50kg



Height adjustment of shelves



3-point lock



Large capacity

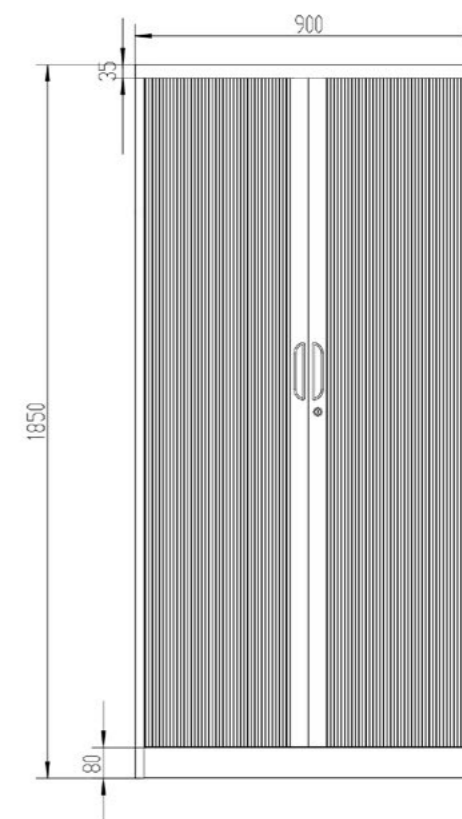
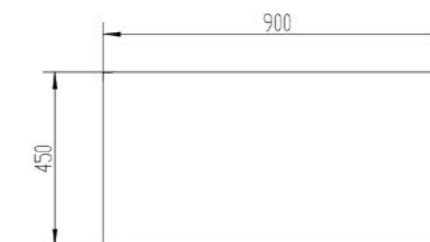

Model: DANIEL



Colours:



DANIEL is a metal cabinet locked with a combination electric lock. Thanks to such a solution, DANIEL will find use wherever exceptional security of stored documents or items is important. This model is ideal for offices and medical facilities. Its capacious interior with four strong, adjustable shelves will accommodate a really large number of binders, documents or small equipment. The DANIEL cabinet is characterized not only by its functionality and durability, but also by its elegant, timeless design.

Description

Size:	1850x900x400mm	Steel thickness:	0,6 mm
Cabinet weight:	43,5 kg	Warranty:	6 years
Package dimensions:	194,5x99x8,5 cm	Certificate:	PZH
Material:	Powder coated steel		

For which rooms:



Offices, secretariats



Doctors' offices, clinics



Schools



Logistics companies, transportation companies



Police, city guard

Advantages of DANIEL cabinet:

- The use of an electric, cipher lock ensures safety and protection;
- The contents of the cabinet from unauthorized persons (the cabinet meets the requirements of GDPR 2018);
- The cabinet has 4 very durable shelves, where the load capacity of each shelf is up to 50 kg. Thanks to the holes in the walls of the closet, you can adjust the height of the shelves every 25mm and adjust the usable space to your needs;
- The interior of the closet DANIEL can accommodate up to 50 segregators;
- Classic design is perfect for stylish rooms;
- The cabinet is made of 0.6 mm thick powder-coated steel, which makes it extremely resistant to mechanical damage;
- Holes in the back wall allow it to be attached to the wall, thus increasing the security in the room;
- The cabinet is available in many color variants, it easily blends in with other models from the Jan Nowak offer;
- Simple, quick self-assembly.

Main features:



Adjustable shelves



High quality steel = exceptional durability



Elegant design



Electronic lock

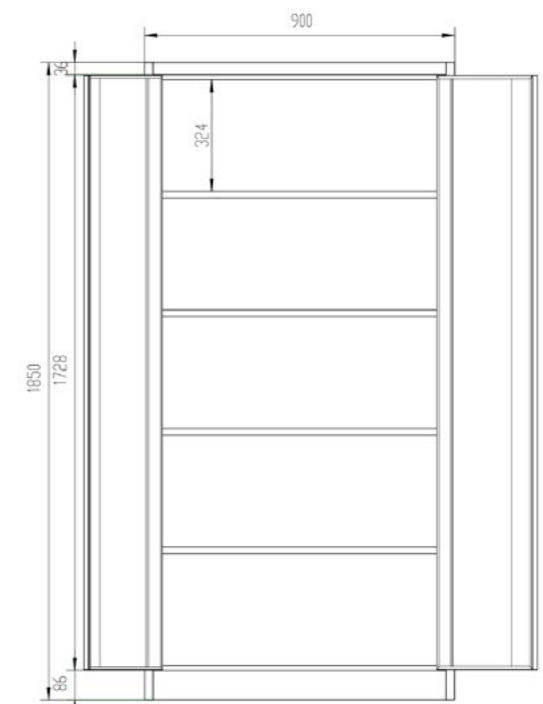
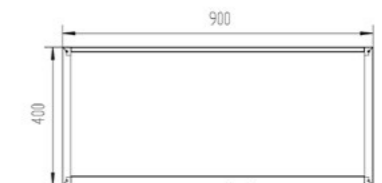

Model: EDMUND



Colours:



Multi functional EDMUND cabinet with three separate sections for storage. Two spacious ones with shelves and a convenient one with drawers for accessories. Elegant glazing of the upper bay door makes the model look great in offices and cabinets. For adequate security, each zone has a separate key lock. EDMUND cabinet is perfect for storing documents.

Description

Size:	1850x900x400 mm	Shelf load capacity:	50 kg
Cabinet weight:	49 kg	Certificate:	PZH
Material:	Powder coated steel	Package dimensions:	79,5x50x17,5 cm
Steel thickness:	0,6 mm		

For which rooms:



Accounting offices and accounting departments.



Secretariats, dean's offices



Hospitals, clinics, doctors' offices, outpatient clinics



Cooperatives, housing communities



Police units, municipal police forces

Advantages of EDMUND cabinet:

- Glazed doors to the upper zone add elegance, making the model ideal for offices;
- Practical zoning, makes it easy to stay organized and find the documents and items you need;
- All storage compartments lockable with a separate lock (two keys for each lock included);
- Heavy-duty shelves. The load capacity of each of them up to 50 kg allows you to store a large number of binders and other items in the cabinet;
- Thanks to the height adjustment of the shelves (in increments of 25 mm), the cabinet can always be adjusted to individual needs;
- The sturdy construction is made of powder-coated 0.6 mm thick steel sheet, which makes the cabinet solid and reliable even after years of intensive use;
- The EDMUND model is suitable for storing documents with sensitive data in accordance with current GDPR requirements;
- Simple, quick self-assembly.

Main features:



3 storage zones



Storage of documents in compliance with GDPR 2018.



Storage compartments secured with individual key.



Solid powder-coated steel



Large shelf load capacity of 50 kg



6 year warranty

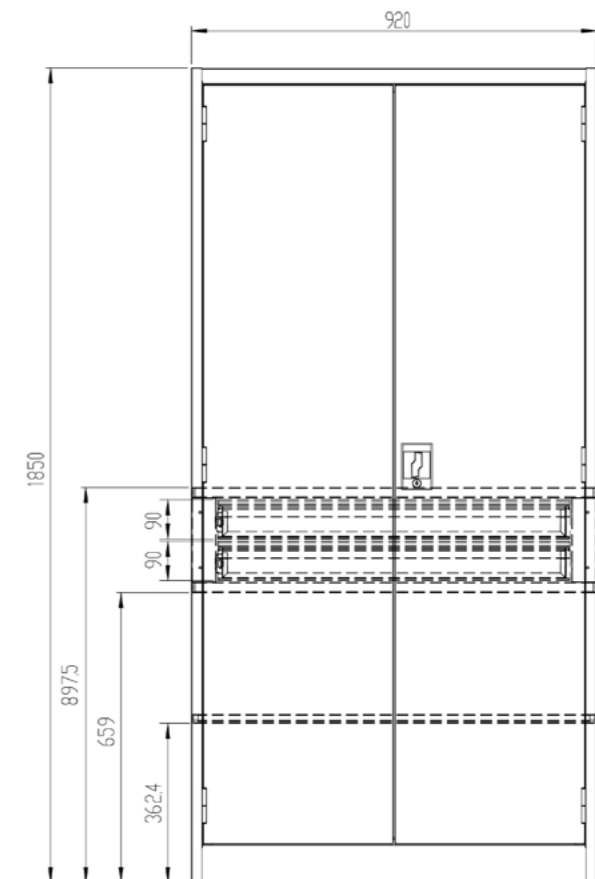

Model: EWA



EWA office upper cabinet allows you to get additional storage space without limiting the free space in the interior. It will prove especially useful in small rooms, where a lot of documentation or other objects are stored. EWA upper cabinet is a model matched to FILIP, FILIP II, KEVIN, JAN, JAN H, AMELIA, DANIEL, KUBA, MAGDA and EDMUND metal cabinets.

Description

Size:	380x900x400 mm	Shelf load capacity:	50 kg
Weight of the cabinet:	11 kg	Certificate:	PZH
Material:	Powder coated steel	Package dimensions:	99x49x11 cm
Steel thickness:	0,6 mm		

Colours:



For which rooms:



Accounting offices and accounting departments



Secretariats, dean's offices



Hospitals, clinics, doctors' offices, outpatient clinics



Cooperatives, housing communities



Police, municipal police units

Advantages of EWA office upper cabinet:

- Compatible with cabinets: FILIP, FILIP II, KEVIN, JAN, JAN H, AMELIA, DANIEL, KUBA, MAGDA, EDMUND;
- Enlarges storage capacity without taking up valuable interior space;
- Perfectly matched height for document storage. 38 cm allows you to easily accommodate standing binders;
- The extension closes with a separate lock (2 keys included);
- The strong construction is made of powder-coated 0.6 mm thick steel sheet, which makes the overhead unit solid and reliable even after years of intensive use;
- The EWA model is suitable for storing documents with sensitive data in accordance with current GDPR requirements;
- Can be attached to the wall for complete stability;
- Simple, quick self-assembly.

Main features:

- Document storage compliant with GDPR 2018.
- Locking mechanism with 3-point locking.
- 2 keys included
- Solid powder-coated steel
- Large load capacity of 50 kg
- 6 year warranty

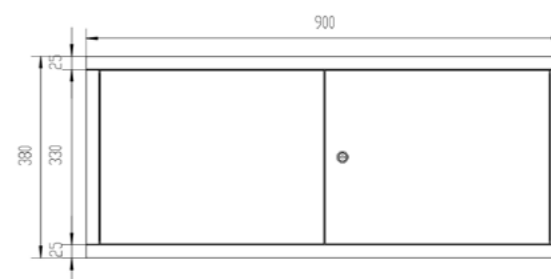

Model: FILIP



FILIP is a cabinet that combines many unique features - a glass display case, a safe, 3 drawers and shelves. This multi-purpose closet will be great for storing various items at the same time: medicines, documents or small appliances, and in the safe - money or valuable items. The safe is an integral part of the closet and its contents are protected by double doors locked with keys and a mechanical/encryption lock. Glazed doors give the FILIP closet lightness and facilitate quick access to the contents on each shelf.

Description

Size:	1850x900x400mm	Material:	Powder coated steel
Cabinet weight:	54,5 kg	Steel thickness:	0,6 mm
Package dimensions:	194x100x8,5 cm	Warranty:	6 years
		Certificate:	PZH

Colours:

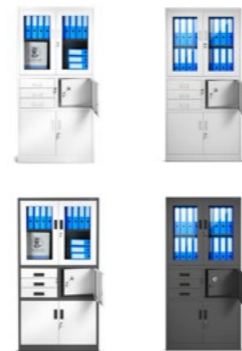

For which rooms:



Offices, schools, secretariats



Hospitals, clinics, treatment rooms, school nurse's offices



Beauty salons

FILIP cabinet advantages:

- Multi-purpose - will work well for storing medicines, documents, medical equipment, money, etc.;
- The safe, which is an integral part of the cabinet, is an ideal place for storing particularly valuable items - the contents of the safe are protected by two keyed doors and a combination-mechanical lock;
- Two-wing doors in the glazed and lower part of the cabinet are secured with 3-point bolted locks, which improves security;
- Classically stylish: simple, elegant design combines with exceptional functionality;
- 4 sturdy shelves - can withstand a load of up to 50kg;
- Adjustable shelves in 25mm increments, allowing you to customize the cabinet to your needs;
- The model is adapted to the regulations of GDPR 2018;
- The cabinet can be attached to the wall, and thus improve the security of its use in the office or study;
- Simple, quick self-assembly.

Main features:



Safe = security of its contents



Glazed door



3-point lock



Possibility to adjust the height of the shelves



High capacity and durability (50 files / 200kg)

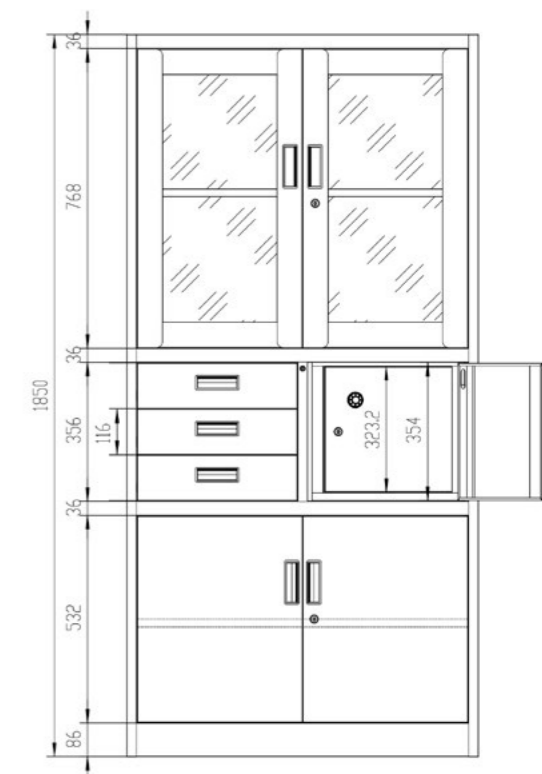

Model: FILIP II



FILIP II is a closet that has as many as 4 different storage zones. This makes it easier to organize stored items and makes it easier to keep things in order. The user has at their disposal spacious niches with shelves (at the top and bottom of the closet), 3 drawers and a safe hidden behind classic doors. Valuables hidden in it are protected by two key locks and a mechanical-digital lock. FILIP II closet looks elegant, so it is perfect for offices or cabinets.

Description

Size:	1850x900x400mm	Material:	Powder coated steel
Cabinet weight:	45 kg	Steel thickness:	0,6 mm
Shelf load capacity:	50 kg	Warranty:	6 years
Package dimensions:	194x100x9 cm	Certificate:	PZH

Colours:



For which rooms:

 Doctors' offices, clinics

 Offices, secretariats

 Beauty salons

 Police, municipal guards

Advantages of FILIP II cabinet:

- Practical zoning makes it easier to organize stored items, but also makes it faster to find the things you need. The closet has two spacious zones with shelves, 3 drawers and a recess with a safe;
- Adjustable shelves have the ability to change their height in 25 mm increments. The user decides for themselves what the interior of the cabinet looks like. The load capacity of the shelves is as much as 50 kg;
- Hidden behind the cabinet door, the safe provides discretion, but also increases security. Access to valuable items is protected by as many as three systems. Two key locks and a mechanical/digital lock;
- Convenient and quick access to drawers. One lock allows all units to be opened and closed;
- FILIP II is suitable for storing documents with sensitive data in accordance with GDPR 2018 guidelines. Excellent protection is provided by 3-point key locks and special reinforcements on the doors. Two keys are included for each lock;
- The cabinet has the ability to mount to the wall, this functionality protects the furniture from falling;
- Clear instructions make it easier and faster to assemble the cabinet.

Main features:

-  Hidden safe.
-  GDPR 2018 compliant document storage.
-  Locks that lock at 3 points.
-  Solid powder-coated steel
-  Large shelf load capacity - 50 kg
-  6 year warranty

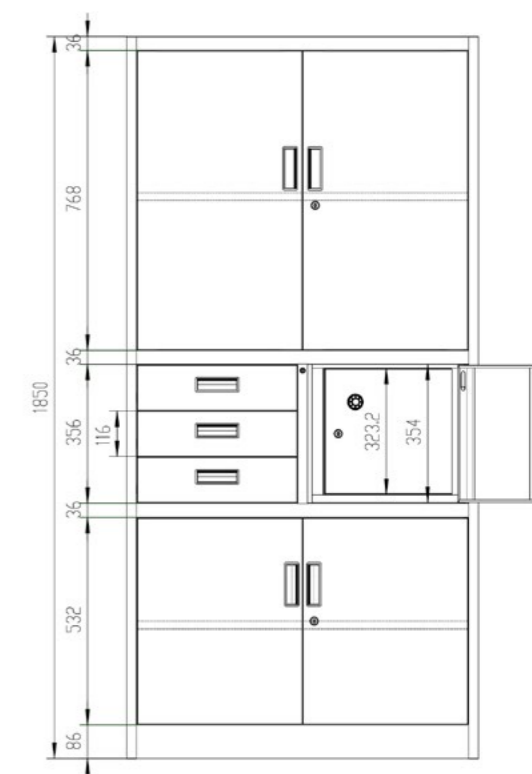
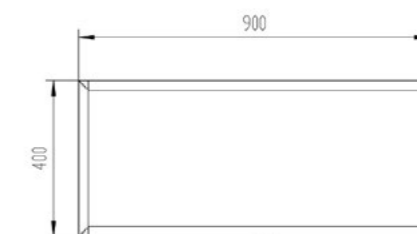

Model: JAN



Colours:



JAN is the most popular and versatile cabinet in the JAN NOWAK assortment. It is a sturdy model made of strong powder-coated steel, which is perfect for storing documents (it will hold up to 50 binders), valuable items or tools. The two-wing doors are locked with a 3-point lock - the cabinet meets the requirements of GDPR.

Description

Size:	1850x900x400mm	Steel thickness:	0,6 mm
Cabinet weight:	44 kg	Warranty:	6 years
Package dimensions:	194,5x55,5x14,5 cm	Certificate:	PZH
Material:	Powder coated steel		

For which rooms:



Locker rooms of manufacturing companies, etc.



Clinics, hospitals, laboratories, doctors' offices



Garages







Uniformed services

Advantages of JAN cabinet:

- Modern design and a dozen colors to choose from - so you can easily match the cabinet to any interior;
- Cabinets can be freely composed with other furniture in the color of the body from the Jan Nowak offer;
- Thanks to the very high strength of the shelves, it is possible to store documents or objects weighing up to 50kg on each of them;
- Thanks to the free arrangement of the height of the shelves (every 25mm) you can adjust the inside of the cabinet to your own needs;
- 3-point lock locks the door in three places and prevents unauthorized people from opening it;
- Reinforced doors increase the strength of the cabinet and the safety of stored documents;
- Holes in the back wall of the cabinet allow it to be attached to the wall, thus increasing security;
- Cabinet meets the requirements of GDPR 2018 - ensures the security of stored documents;
- Simple, quick self-assembly.

Main features:

-  Design inspired by nature
-  3-point lock
-  High durability of shelves
-  Adjustment of shelves
-  Large selection of colors

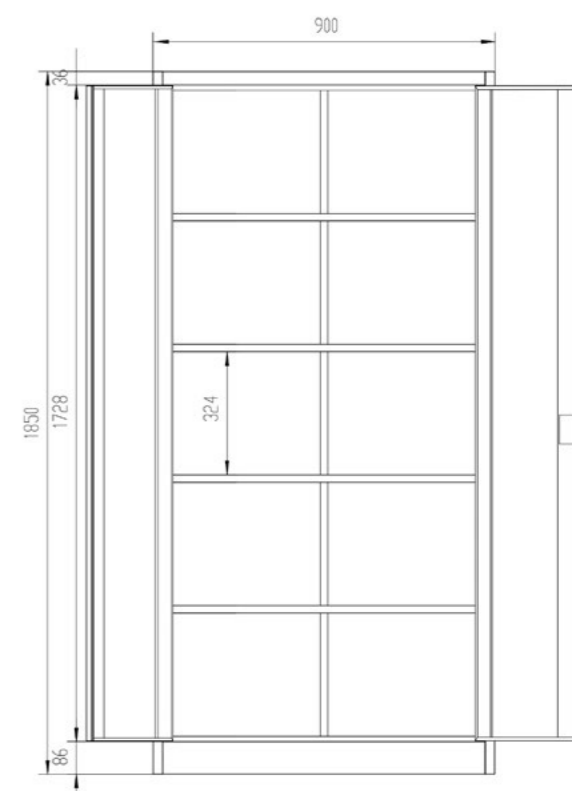
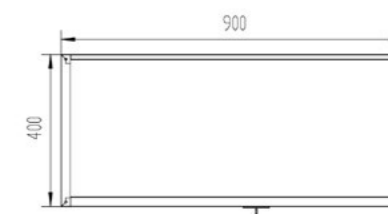

Model: JAN H



JAN H is a wardrobe with high functionality, based on the bestselling model JAN, with its height increased to 195 cm. The user has access to ample space, and thanks to shelf adjustment, can comfortably store large-sized items. It is perfect for storing documentation, as the interior is protected by a three-point locking system. Inside, it can even accommodate up to 50 binders.

Description

Size:	1950x900x400mm	Steel thickness:	0,6 mm
Cabinet weight:	45 kg	Warranty:	6 years
Package dimensions:	204x99,5x8,5 cm	Certificate:	PZH
Material:	Powder coated steel		

Colours:



For which rooms:



Clinics, hospitals, laboratories, doctors' offices



Schools, government and council offices



Businesses, industrial plants



Police

Advantages of JAN H cabinet:

- A classic document cabinet with increased height – up to 195 cm, enabling excellent organisation of items of irregular dimensions. An ideal solution for storing documentation, tools, or office accessories.
- The JAN H cabinet set includes 4 sturdy shelves, each with a load capacity of up to 50 kg.
- Special design and durable handles allow for quick and convenient shelf repositioning. Height adjustment every 25 mm, enabling every user to customise the cabinet interior to their needs.
- Items stored inside are secure, as the doors are reinforced, and access to the interior is blocked by a strong lock bolted in 3 points. Two keys are included in the set.
- The sturdy key lock ensures that sensitive data can be stored in accordance with the GDPR guidelines (2018).
- The cabinet can be wall-mounted, minimising the risk of furniture tipping over.
- Intuitive and quick installation

Main features:



4 adjustable shelves



GDPR 2018 compliant document storage.



3-point locking mechanism



Solid powder-coated steel



Large shelf load capacity - 50 kg



6 year warranty

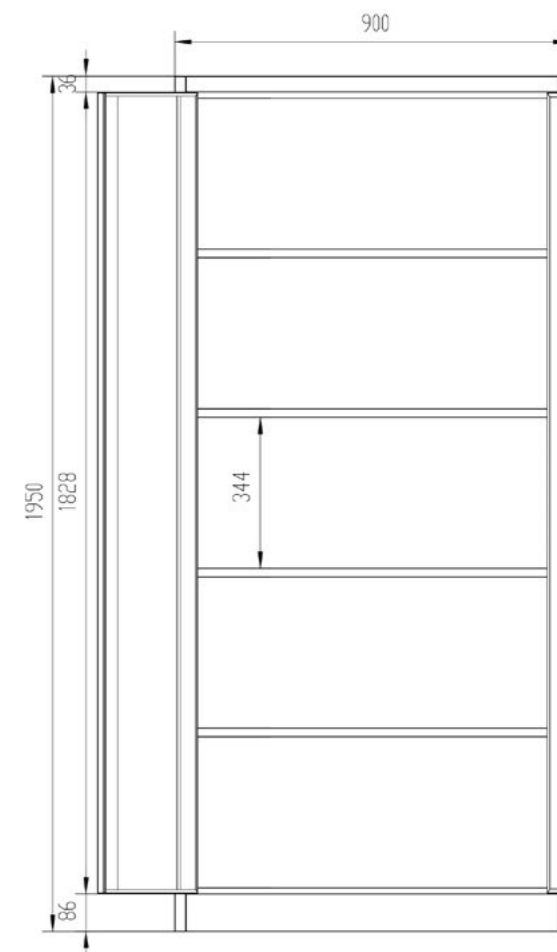
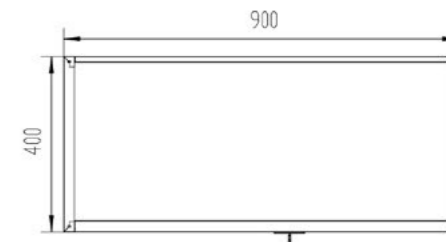

Model: JAN II

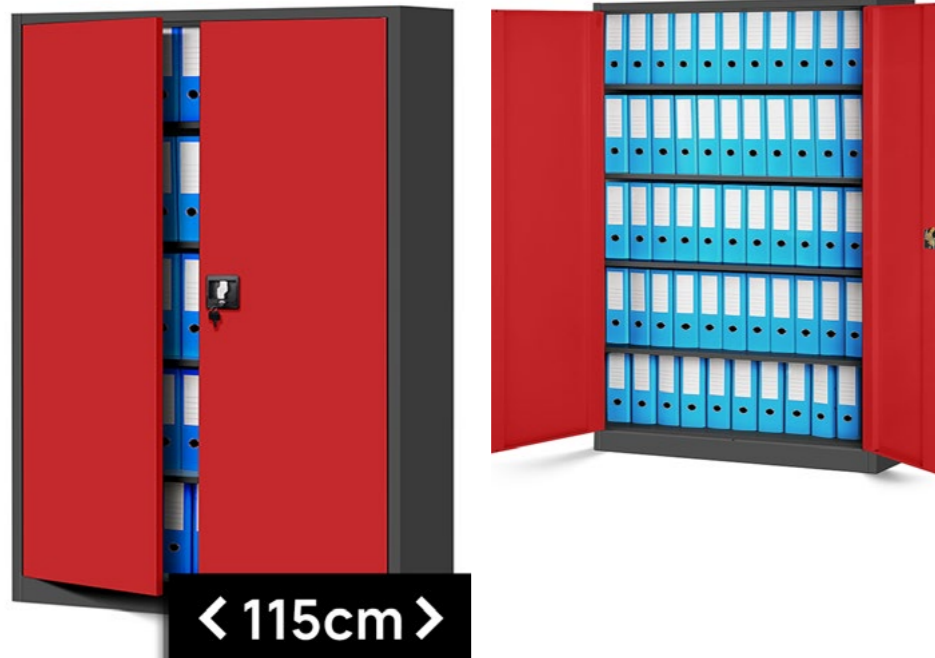

JAN II is an expanded version of the bestselling closet with adjustable shelves. As much as 115 cm in width increases the storage capacity even more. The capacious piece of furniture is capable of storing as many as 60 binders. It makes it the most capacious cabinet in the entire range. Documents and other valuable items inside are protected by a three-point lock.

Description

Size:	1850x1150x400mm	Shelf load capacity:	50 kg
Cabinet weight:	50 kg	Steel thickness:	0,6 mm
Package dimensions:	194x125x8,5 cm	Warranty:	6 years
Material:	Powder coated steel	Certificate:	PZH

Colours:





For which rooms:

 Offices, secretariats

 Doctors' offices, clinics

 Schools

 Businesses, industrial plants

 Police, municipal guards

Advantages of JAN II cabinet:

- Classic closet with increased width - 115 cm, which significantly affects the packability of the furniture. It is perfect for storing documentation, tools or office accessories;
- The model comes with 4 sturdy shelves with a load capacity of up to 50 kg each;
- The shelves are mounted on sturdy hooks, allowing you to quickly change the height of each shelf. The position can be adjusted in 25mm increments. This allows the user to adjust the position of the shelves to suit individual needs;
- The cabinet has a 3-point lock, which provides security and blocks unauthorized access. Two keys are included;
- For increased durability and security of the cabinet, the doors have been reinforced. The JAN II model allows you to store data in accordance with the requirements of GDPR 2018;
- There are special holes in the body, which allow the cabinet to be attached to the wall, thereby increasing security and eliminating the risk of falling over;
- Simple, quick self-assembly.

Main features:

-  4 adjustable shelves
-  Large width, great capacity
-  GDPR 2018 compliant document storage.
-  3-point locking mechanism
-  Solid powder-coated steel
-  Large shelf load capacity - 50 kg

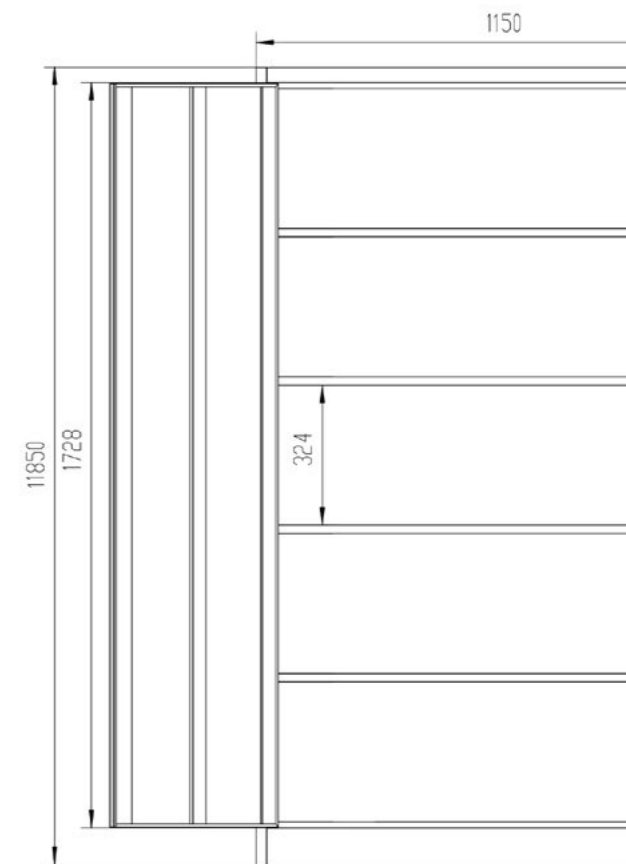
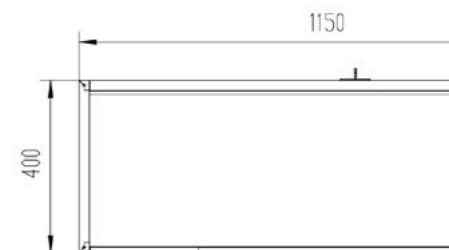

Model: KEVIN

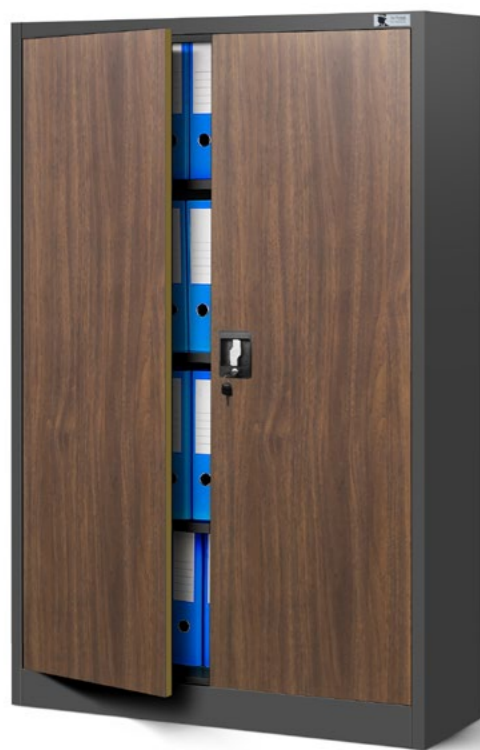

KEVIN cabinet with a medium height of 140 cm combines the ability to safely store items inside, but also to place appliances, accessories or decorations on it. As a result, it will gain in practicality and aesthetics. The interior of the KEVIN cabinet is divided into four niches, which can be adjusted to the size of the stored items. The model is equipped with a solid lock bolted in three places.

Description

Size:	1400x900x400 mm	Shelf load capacity:	50 kg
Cabinet weight:	34 kg	Certificate:	PZH
Material:	Powder coated steel	Package dimensions:	149x100x10,5 cm
Steel thickness:	0,6 mm		

Colours:





For which rooms:

 Accounting offices and accounting departments.

 Secretariats, dean's offices

 Hospitals, clinics, doctors' offices, outpatient clinics







 Cooperatives, housing communities

 Units of the police, municipal police.

Advantages of KEVIN cabinet:

- The height of 140 cm allows you to put away items on the cabinet. It gives you the opportunity to provide extremely fast access to the necessary office accessories or equipment;
- The cabinet door is secured by a solid lock, bolted in three places. It makes the model perfect for storing documentation in accordance with GDPR requirements;
- Heavy-duty shelves. The load capacity of each of them up to 50 kg allows you to store a large number of files and other items in the cabinet;
- Internal rack equipped with holes spaced every 25 mm gives you a chance to adjust the height of the shelves to suit your needs;
- The sturdy construction is formed from powder-coated 0.6 mm thick steel sheet, which makes the cabinet sturdy and reliable even after years of intensive use;
- Simple, quick self-assembly.

Main features:

-  3 adjustable shelves
-  GDPR 2018 compliant document storage.
-  Three-point locking mechanism
-  Solid powder-coated steel
-  Large shelf load capacity of 50 kg
-  6 year warranty

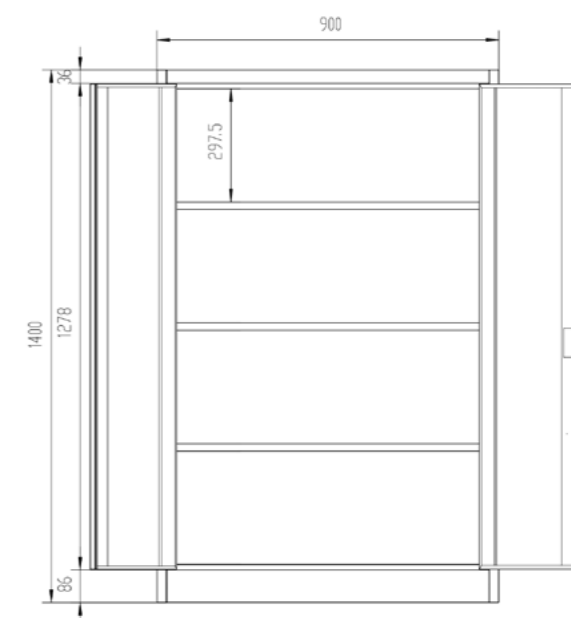
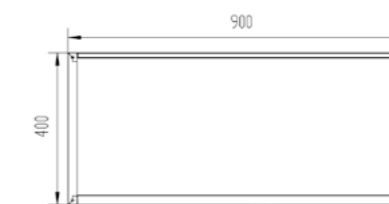

Model: KUBA



KUBA is a closet model, which is distinguished by 3-point-locking sliding doors. Thanks to such a solution, this closet is perfect for narrow rooms or right next to entrances, where there is no room for traditionally opened cabinets. This model will work well for storing documents, binders with documentation, medicines, food products such as in home pantries and tools in small storage or garage spaces.

Description

Size:	1850x900x400mm	Steel thickness:	0,6 mm
Cabinet weight:	45,5 kg	Warranty:	6 years
Package dimensions:	194,5x56x15 cm	Certificate:	PZH
Material:	Powder coated steel		

Colours:







For which rooms:

-  Doctors' surgeries, dental surgeries, treatment rooms
-  Clinics, laboratories
-  Offices, housing communities
-  Home office / apartment, home pantry
-  Secretariats and dean's offices, schools
-  Basements, garages

Advantages of KUBA cabinet:

- Sliding doors will allow access to the contents of the cabinet even in very narrow rooms;
- The cabinet has 4 very durable shelves, where the load capacity of each shelf is up to 50 kg;
- Thanks to holes in the walls of the closet you can adjust the height of the shelves every 25mm and adjust the usable space to your needs;
- Interior of KUBA closet can accommodate up to 50 files;
- The use of a 3-point lock ensures the safety and protection of the contents of the cabinet from unauthorized persons (the cabinet meets the requirements of GDPR 2018);
- The cabinet is made of powder-coated 0.6 mm thick steel, which makes it extremely resistant to mechanical damage;
- Holes in the back wall allow it to be attached to the wall, and thus increase security in the room;
- The door prevents dust from getting on stored items in rooms such as basements or garages;
- Simple, quick self-assembly.

Main features:

-  Easy access to the interior of the cabinet
-  Height adjustment of shelves
-  3-point lock
-  Large capacity

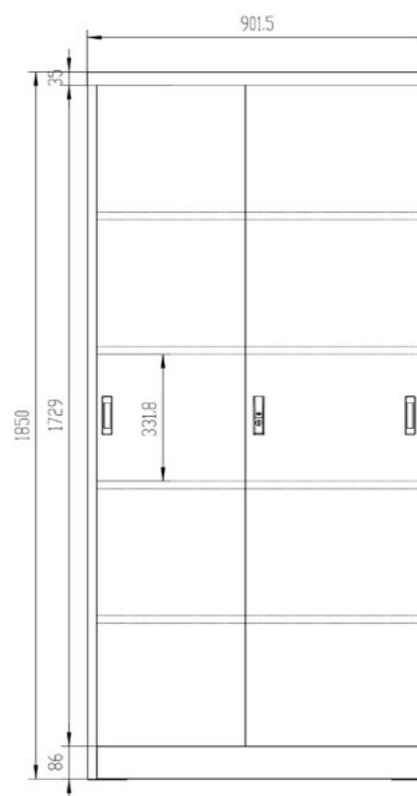
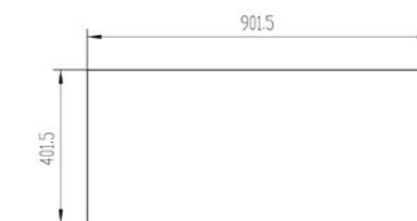

Model: LENA



Colours:



LENA cabinet is a model created for places where practical and compact solutions are necessary. It has a large niche with a shelf and two drawers. So you can store documents but also office accessories and small tools in it. Dividing the interior of the cabinet into zones makes it much easier to maintain order. Both the cabinet and drawers have a separate key lock.

Description

Size:	900x900x400 mm	Shelf load capacity:	50 kg
Weight of the cabinet:	29 kg	Certificate:	PZH
Material:	Powder coated steel	Package dimensions:	99x99,5 10 cm
Steel thickness:	0,6 mm		

For which rooms:



Accounting offices and accounting departments.



Secretariats, dean's offices



Hospitals, clinics, doctors' offices, outpatient clinics



Cooperatives, housing communities



Units of the police, municipal police.

Advantages of LENA cabinet:

- Small size makes the cabinet perfect for small rooms and does not cause an overwhelming effect;
- Two drawers will work well for storing small items such as stamps, office accessories or small tools;
- The cabinet doors and drawers are secured with a solid lock. Each lock has two keys;
- The cabinet has one shelf with adjustable height in 25 mm increments. It allows you to adjust the interior for individual needs. The load capacity of the shelf is 50 kg;
- With robust locks, the cabinet is suitable for storing files with sensitive data in accordance with GDPR requirements;
- The sturdy construction is made of powder-coated 0.6 mm thick steel sheet, which makes the cabinet sturdy and reliable even after years of intensive use;
- Simple, quick self-assembly.

Main features:

- ≡ Practical storage zones
- 🔒 GDPR 2018 compliant document storage.
- 🔑 Three-point locking mechanism
- 🔲 Solid powder-coated steel
- 📦 50kg Large shelf load capacity of 50 kg
- 🛡️ 6-year warranty

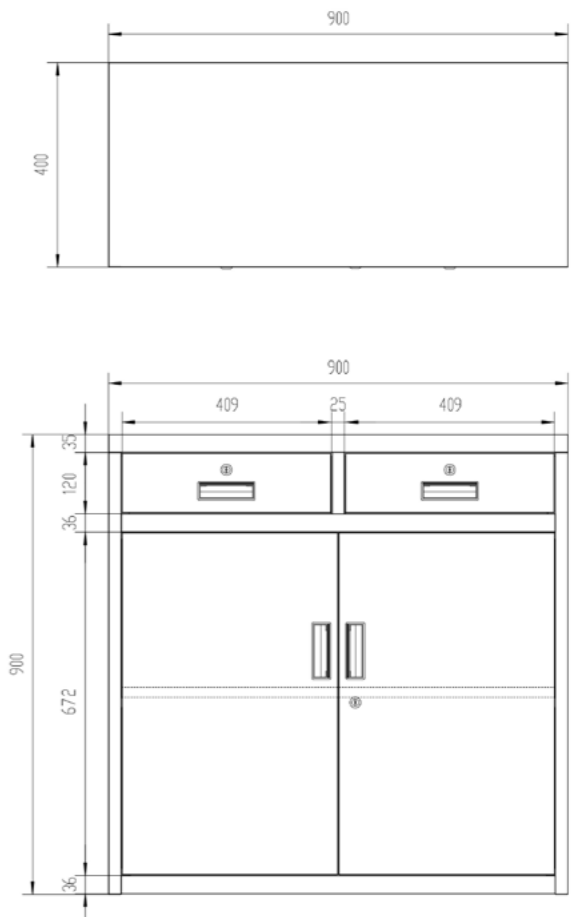

Model: MAGDA



The MAGDA model is one closet with the functionality of two, as it has been divided into two completely separate zones. Each of them has a business card holder and is secured by a separate lock, so you can efficiently manage access to stored things. Inside the lower and upper parts there is a shelf, the height of which can be independently adjusted. Due to the spacious interior, the MAGDA cabinet is suitable for both the office, workshop and warehouse.

Description

Size:	1850x900x400 mm	Shelf load capacity:	50 kg
Cabinet weight:	40 kg	Certificate:	PZH
Material:	Powder coated steel	Package dimensions:	193,5x100x8,5 cm
Steel thickness:	0,6 mm		

Colours:



For which rooms:



Accounting offices and accounting departments.



Secretariats, dean's offices



Hospitals, clinics, doctors' offices, outpatient clinics



Cooperatives, housing communities



Workshops, production facilities, warehouses

Advantages of MAGDA cabinet:

- The spacious interior of the MAGDA cabinet is able to accommodate up to 48 files;
- Two storage sections allow you to conveniently sort documents or separate them from other items as needed;
- Separate locks for the upper and lower levels make it easy to manage access to stored items. Robust locking is provided by a three-point locking mechanism;
- Ability to customize the interior of the cabinet to suit your needs. The shelves are height-adjustable in 25 mm increments. The load capacity of each level is up to 50 kg;
- Space for a business card holder allows you to catalog your stored items, which, as a result, speeds up finding the necessary documents;
- The cabinet is made of 0.6 mm thick sheet metal, when folded, it is extremely solid and stable. Strong materials make the structure resistant to damage and easy to clean;
- The MAGDA model is practical and you can safely store files with personal data in it, as it is adapted to the requirements of GDPR 2018;
- Simple, quick, self-assembly.

Main features:

- ≡ 2 storage zones
- Document storage compliant with GDPR 2018.
- Storage compartments secured by individual key.
- Locks interlocked at three points
- Solid powder-coated steel
- Large shelf load capacity of 50 kg
- 6 year warranty

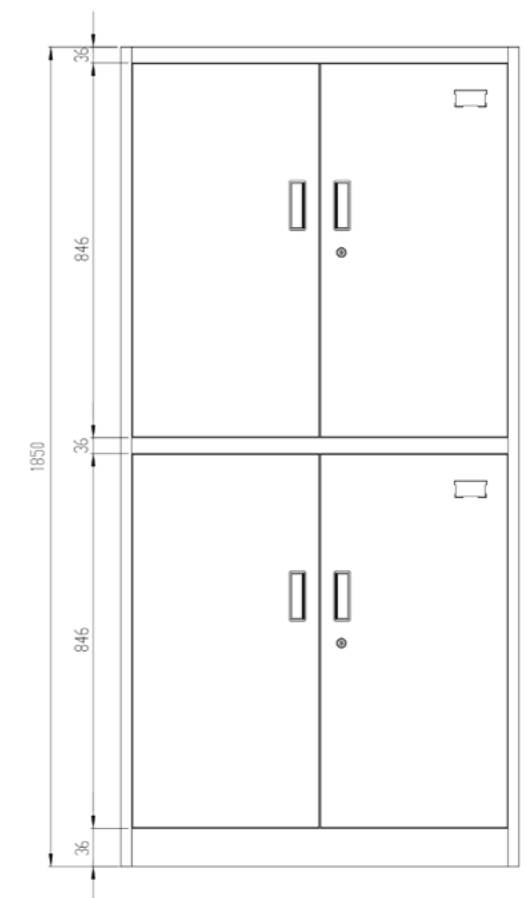

Model: SARA 3



Colours:



The smallest variant of the filing cabinet with three drawers ideally suited for storing files and documents. Robust key locking allows you to safely store personal data in accordance with the 2018 GDPR regulation. The compact cabinet allows you to store a large number of files, and at the same time does not overwhelm the space in which it is located.

Description

Size:	460x1020x620 mm	Drawer dimensions:	Depth: 51 cm Height: 25 cm Internal width: 38 cm
Weight of the cabinet:	28 kg	Drawer load capacity:	40 kg
Material:	Powder coated steel	Certificate:	PZH
Steel thickness:	0,6 mm		
Package dimensions:	111x72x8 cm		

For which rooms:



Hospitals, clinics, doctors' offices.



Accounting offices and accounting departments



Secretariats, dean's offices



Police, municipal guards









Cooperatives, housing communities

Advantages of SARA 3 cabinet:

- The smallest variant of the filing cabinet with 3 drawers. Ideal for small clinics, housing communities or accounting offices that do not need a large number of drawers for documents;
- Practical lock, all drawers are locked with one key. The cabinet allows you to store data in accordance with GDPR requirements;
- 3 capacious, durable drawers, which can accommodate a large number of cards and folders. The permissible load of each drawer is up to 40 kg;
- A special system that prevents the furniture from tipping over. The mechanism blocks the extension of more than one drawer at a time, which prevents the cabinet from leaning forward under the weight of documents;
- Adjustable dividers are included for convenient storage of smaller sized files and folders;
- Business card holders on the front of the drawers will help you organize your files and find the documents you need faster;
- Drawers mounted on sturdy slides that guarantee smooth and quiet operation even under heavy load;
- Quick, hassle-free installation.

Main features:

-  Robust, interlocking lock
-  Roll-over protection system
-  Large drawer load capacity of 40 kg.
-  Business card holder on each drawer.
-  Adjustable dividers
-  6-year warranty

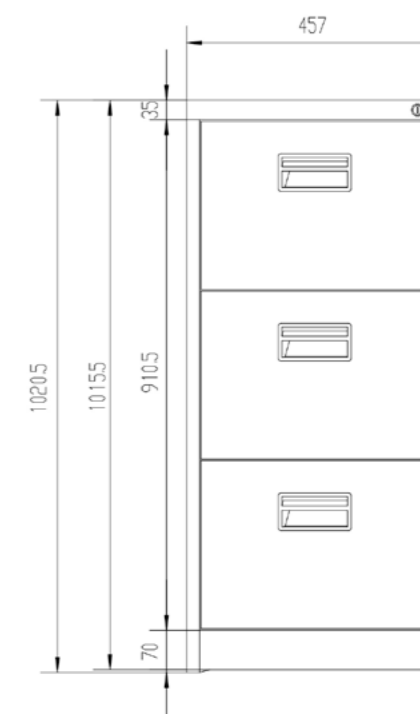

Model: SARA 4



SARA is our bestselling file cabinet, thanks to which you can easily ensure the structure and security of your stored documents and personal files, in accordance with the 2018 GDPR regulation. The cabinet is equipped with well-thought-out design solutions that ensure comfortable, safe and discreet use in all types of offices.

Description

Size: 1320x460x620mm

Weight of the cabinet: 42 kg

Package dimensions: 141x72x8 cm

Material: Powder coated steel

Drawer dimensions: Depth: 51 cm
Height: 25 cm
Width inside: 38 cm

Steel thickness: 0,6 mm

Warranty: 6 years

Certificate: PZH

Colours:





For which rooms:

 Hospitals, clinics, doctors' offices.

 Accounting offices and accounting departments

 Secretariats, dean's offices





 Police, municipal guards

 Cooperatives, housing communities

Advantages of SARA 4 cabinet:

- Thanks to its small dimensions, the file cabinet will work well even in the smallest offices;
- Document security is protected by a bolted lock - the cabinet meets the requirements of GDPR;
- 4 capacious, durable drawers will accommodate a large number of documents - up to 40 kg in each of them;
- A security system that prevents more than one drawer from being pulled out at the same time. This ensures that the cabinet will not tip over under the weight of documents;
- Movable bar, the position of which can be adjusted to the size of folders / files hung in the drawer;
- You can arrange the documents according to your own key and mark the business card holder on each drawer accordingly;
- Thanks to solid slides, drawers open smoothly and quietly;
- Simple, quick installation.

Main features:

-  Large capacity with small size
-  Adjustment of drawers to the size of files: A4 / F4
-  Storage security - bolt lock
-  Anti-tipping system
-  High capacity of the drawer - 40kg

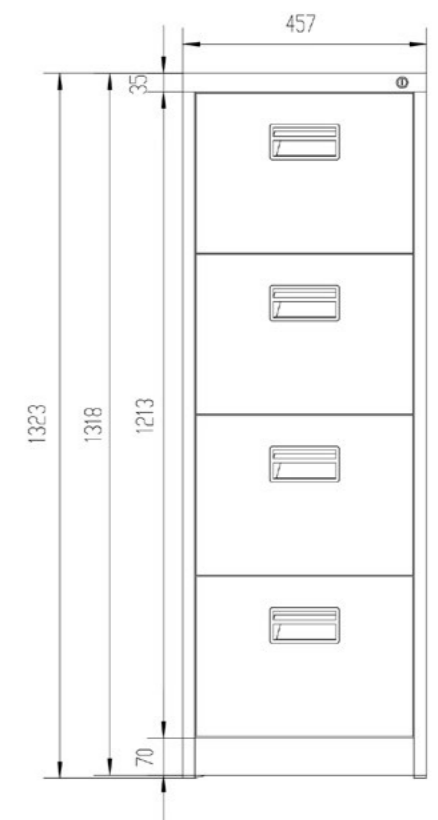

Model: SARA 5



Colours:



A file cabinet with the largest storage capacity. The model with a raised height has as many as 5 capacious drawers. This is an ideal compromise that allows you to store a large number of documents while maintaining the compact dimensions of the furniture. Thanks to the built lock, personal data is stored in accordance with the rules of GDPR 2018. The practical lock opens and locks all the compartments at once, making it easier and faster to use the cabinet.

Description

Size:	460x1630x620 mm	Drawer dimensions:	Depth: 51 cm Height: 25 cm Width inside: 38 cm
Weight of the cabinet:	49 kg	Drawer load capacity:	40 kg
Material:	Powder coated steel	Certificate:	PZH
Steel thickness:	0,6 mm		
Package dimensions:	170,5x72x8,5 cm		

For which rooms:



Hospitals, clinics, doctors' offices.



Accounting offices and accounting departments



Secretariats, dean's offices



Police, municipal guards



Cooperatives, housing communities

Advantages of SARA 5 cabinet:

- Excellent ratio of the number of drawers to the dimensions of the furniture. Cabinet with 5 drawers allows you to store a significant number of documents while maintaining a small size. Model recommended for large clinics, dean's offices, accounting offices;
- To speed up access to files, all drawers open with a single lock. Keyed security allows you to store personal data in accordance with GDPR requirements;
- With 5 sturdy and capacious drawers with a load capacity of 40 kg, the file cabinet can easily accommodate the required number of records;
- Built-in protection against tilting of the furniture under the weight of documents. The mechanism blocks the opening of more than one drawer at a time;
- Special adjustable dividers allow you to conveniently store documents of smaller dimensions;
- For professional organization of data you can use business card holders placed at the handle, in which you can put information about the contents of each drawer;
- Robust slides affect the quiet and smooth operation of the drawer regardless of the load;
- Quick and hassle-free installation.

Main features:

- ✓ Large capacity in a small size.
- 📄 Drawers tailored to fit A4 size.
- 🔒 Robust, interlocking lock
- 🛡️ Roll-over protection system
- 📁 Large drawer load capacity of 40 kg.
- 👤 Business card holder on each drawer.
- ⬆️⬆️ Adjustable dividers
- 🛡️ 6-year warranty

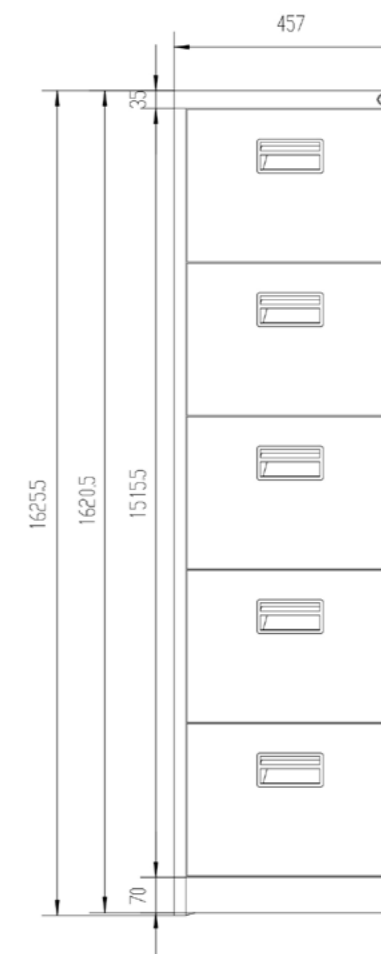

Model: TOMASZ



Colours:



Model TOMASZ is a classic closet with shelves, which has an additional storage compartment locked with a separate lock. Robust, adjustable shelves with a load capacity of 50 kg make the model ideal for storing documentation, as well as tools or small equipment. The three-point locking mechanism will allow you to safely store sensitive data in accordance with GDPR 2018 requirements.

Description

Size:	1850x900x450mm	Shelf load capacity:	50 kg
Cabinet weight:	45 kg	Certificate:	PZH
Material:	Powder coated steel	Package dimensions:	194x100x8,5 cm
Steel thickness:	0,6 mm		

For which rooms:



Offices, secretariats



Fire brigade units



Police stations and police headquarters, municipal police stations



Car workshops, manufacturing plants, warehouses



Sports clubs, SPA salons, beauty salons

Advantages of TOMASZ cabinet:

- Additional storage compartment locked with a separate lock in the upper part of the closet is a perfect place for more valuable items or accessories;
- High durability of the shelves. The load capacity of each of them up to 50 kg allows you to store even heavy items or tools in the cabinet;
- Thanks to the height adjustment of the shelves (in 25mm increments), the cabinet can always be adjusted to individual needs;
- A strong 3-point lock secures the items inside;
- The sturdy construction is made of powder-coated 0.6 mm thick steel sheet, which makes the cabinet sturdy and reliable even after years of intensive use;
- TOMASZ will store documents containing personal information in accordance with current GDPR requirements;
- Simple, quick self-assembly.

Main features:



Separate locking compartment



GDPR 2018 compliant document storage.



3-point locking mechanism.



Solid powder-coated steel



Large shelf load capacity of 50 kg



6 year warranty

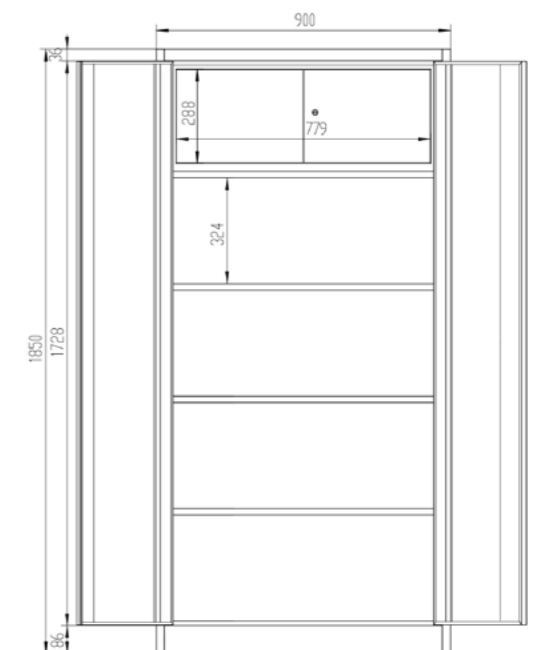
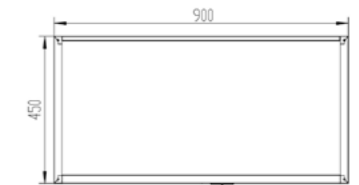

Model: WIOLA



Colours:



WIOLA closet allows for professional organization of stored items due to the division of the interior into 3 practical zones. The top houses a display case with glass doors and adjustable shelves, while the bottom of the closet has 4 drawers and a cabinet with 2 shelves. Each zone has a separate key lock, so you can manage access to specific items even better. The glazed doors of the WIOLA model make the closet look solid and elegant.

Description

Size:	1850x900x450mm	Shelf load capacity:	50 kg
Cabinet weight:	56 kg	Certificate:	PZH
Material:	Powder coated steel	Package dimensions:	194x99x9,5 cm
Steel thickness:	0,6 mm		

For which rooms:



Accounting offices and accounting departments.



Secretariats, dean's offices



Hospitals, clinics, doctors' offices, outpatient clinics



Cooperatives, housing communities









Police, municipal police units

Advantages of WIOLA cabinet:

- The introduction of three separate storage zones (display case, drawers, cabinet) allows for good organization of stored items and makes it easier to maintain order;
- The large upper part of the cabinet with glass doors will speed up finding the needed documentation, but also makes the piece of furniture look exceptionally elegant;
- The storage areas are locked with separate keys. One lock for all drawers significantly speeds up access to needed items. Two keys for each lock are included;
- Heavy-duty shelves. The load capacity of each of them up to 50 kg allows you to store a large number of binders and other items in the cabinet;
- Adjustment of the interior of the upper part of the cabinet, due to the frame that allows you to change the height of the shelves (stroke every 25 mm);
- The cabinet is made of 0.6 mm thick sheet metal, when folded it is extremely solid and stable. Strong materials make the structure resistant to damage and easy to clean;
- WIOLA model is perfect for storing records with sensitive data, as it meets the requirements of GDPR 2018;
- Simple, quick, self-assembly.

Main features:

-  3 storage zones
-  GDPR 2018 compliant document storage.
-  Storage compartments secured with individual key.
-  Solid powder-coated steel
-  Large shelf load capacity of 50 kg
-  6 year warranty

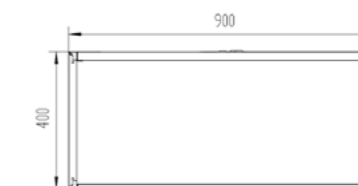



Social Furniture



Model: BARTEK



As many as ten capacious, lockable with strong locks cabinets and only 136 cm wide - the BARTEK locker will provide full storage comfort in any social room. Thanks to its compact design, the furniture will accommodate the clothes and personal items of as many as ten people, and at the same time will save usable space even in the smallest checkroom.

Description

Size:	1720x1350x450mm	Warranty:	6 years
Cabinet weight:	66 kg	Dimensions of the locker:	200x720x420 mm
Material:	Powder coated steel	Certificate:	PZH
Steel thickness:	0,6 mm		
Package dimensions:	171x145,5x9 cm		

Colours:





For which rooms:

 Offices, secretariats

 Doctors' offices, clinics

 Schools







 Logistics companies, transportation companies

 Car workshops, factories, garages

Advantages of BARTEK cabinet:

- Our social cabinet is as much as 10 capacious lockers in one place;
- Construction made of strong 0,6 mm thick steel sheet is a certainty that BARTEK is solid, safe and resistant to mechanical damage;
- Simple, quick, self-assembly;
- Well-thought-out openings in the door ensure great air circulation, make it easier to preserve the freshness of the stored clothes and prevent the accumulation of moisture;
- Thanks to a special place for a name label, each cabinet can be personalized;
- Legs allow for more thorough cleaning of the locker room floor;
- Functional bar will make it easier to hang up clothes and keep order inside the locker;
- BARTEK meets the requirements for storing documents containing personal data - it is GDPR compliant!

Main features:

-  Universal and at the same time elegant design
-  Legs
-  Adequate ventilation
-  Secure lock
-  Space for a business card holder
-  Clothes rod

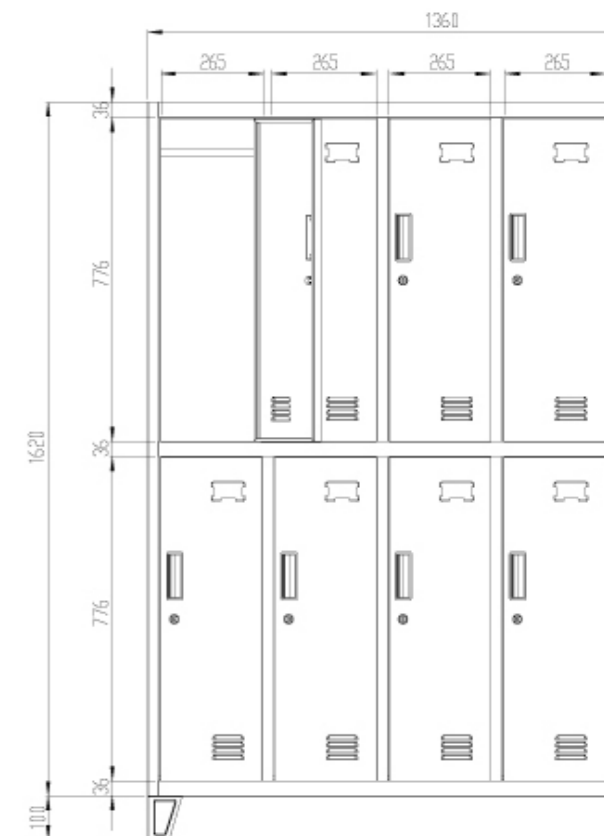

Model: BARTUŚ



Colours:





The interior of a social room does not have to be boring! Colorful metal cabinet BARTUŚ will transform any school or kindergarten locker room, fitness club, swimming pool or gym. This model is only 136 cm wide, but in its capacious cabinets it will store clothes, shoes or personal belongings of up to ten people! BARTUŚ will make the checkroom well-organized and stylish, and the storage will be safe and comfortable.

Description

Size:	1500x1360x450mm	Warranty:	6 years
Cabinet weight:	62 kg	Dimensions of the locker:	240x670x450 mm
Material:	Powder coated steel	Certificate:	PZH
Steel thickness:	0,6 mm		
Package dimensions:	159x145,5x8,5 cm		

For which rooms:

 Schools, kindergartens, nurseries

 Gyms, swimming pools, fitness clubs





 Doctors' offices, beauty salons

 Hotels, hospitals

Advantages of BARTUŚ cabinet:

- As many as ten capacious cabinets that will safely store clothing, footwear or personal items, and if needed, also documents - our closet cabinet is compliant with current GDPR regulations;
- Compact dimensions that make BARTUŚ perfect for both spacious and small locker rooms;
- Openings in our closet provide the necessary air circulation and prevent the accumulation of moisture inside the lockers, so storage becomes not only convenient, but also hygienic;
- A practical rod for hanging clothes on hangers is a way to keep the inside of the locker in order;
- A place for a business card holder on the door of each locker allows you to personalize the lockers, which will make daily use easier for both children and adults;
- Simple, quick, self-assembly.

Main features:

-  Capacious cabinets
-  Original colors
-  Universal key
-  Space for a business card holder
-  Clothes rod



Model: BORYS



Colours:





Extremely capacious and multi functional closet, which includes all the most convenient storage systems. The closet is divided into two separately lockable zones. Inside the main one there are shelves, a clothes rod and lockable drawers. A mirror has been placed on the wall of the door. All the amenities make this model perfect for a doctor's office, beauty salon or laboratory.

Description

Size:	900x1850x500 mm	Load capacity of the shelf:	50 kg
Cabinet weight:	68 kg	Certificate:	PZH
Material:	Powder coated steel	Steel thickness:	0,6 mm
Package dimensions:	194,5x110x9 cm		

For which rooms:

 Utility rooms, social rooms

 Hospitals, doctors' offices, clinics

 Locker rooms, sports clubs, beauty salons







 Offices, law firms

 Workshops, warehouses

Advantages of BORYS cabinet:

- The practical division of the closet introduces excellent organization and makes it easy to keep the inside in order;
- The clothing zone consists of a high recess with a bar and a separate compartment for shoes. Which avoids dirty clothes;
- A separately lockable compartment located on top is suitable for storing archival files and documents;
- An additional two drawers in the middle of the cabinet can be used for small accessories or documentation. A separate key lock will allow you to assign access to the interior only to selected people;
- The security measures implemented allow storing personal data in accordance with the standards of the GDPR 2018 regulation;
- Spacious recesses are an ideal place for binders, tools, cleaning products. The installed shelves are sturdy and stable. Each of them is able to bear a maximum load of 50 kg;
- A built-in mirror in the door will allow you to inspect your appearance before going to a patient or client;
- For maximum stability, the cabinet has the ability to be attached to the wall;
- Quick and easy installation.

Main features:

-  Multi-functional storage zones
-  Document storage compliant with GDPR 2018.
-  3-point locking mechanism
-  Space for business card holder
-  Excellent ventilation
-  Solid powder coated steel
-  6-year warranty

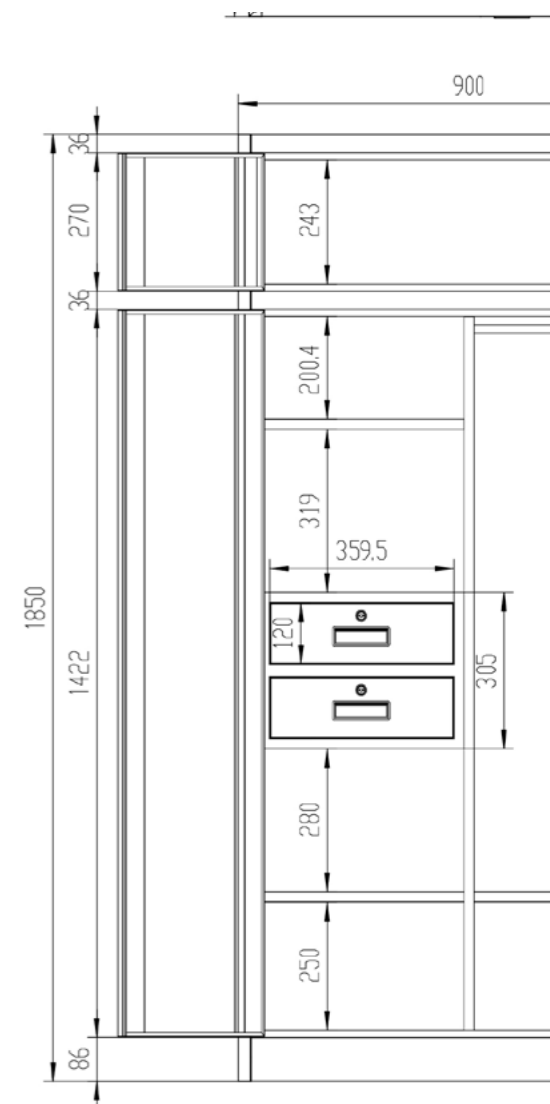

Model: DAWID



Multi functional closet divides into three storage zones, which will make it easier to stay organized and find things faster. Equipped with a large partition with a bar, a section with shelves (4 niches) and a top wide space. The load capacity of the shelves at 50 kg and the solid three-point lock makes the cabinet suitable for a wide range of applications.

Description

Size:	900x1850x450 mm	Shelf load capacity:	50 kg
Cabinet weight:	45 kg	Certificate:	PZH
Material:	Powder coated steel	Package dimensions:	194x99,5x9 cm
Steel thickness:	0,6 mm		

Colours:



For which rooms:



Utility rooms, social rooms



Garages, boiler rooms



Hospitals, doctors' offices, clinics



Workshops, warehouses



Locker rooms, sports clubs, beauty salons

Advantages of DAWID cabinet:

- 3 storage zones make it easy to organize stored items and keep things in order;
- Great ratio of external dimensions to storage capacity;
- The bar mounted in the high bay will allow you to hang clothes without the risk of creases. The bottom compartment is also suitable for storing e.g. shoes, backpacks;
- In the spacious area with shelves you can put away documents, cleaning products or tools. The maximum load of each shelf is 50 kg;
- The upper level with increased width will accommodate larger items or less frequently used, it is also a great place for archival documentation;
- The cabinet is equipped with a sturdy lock bolted in three places, which allows you to store personal data in accordance with the guidelines of the GDPR 2018 regulation;
- To ensure maximum stability, the cabinet has the ability to be attached to the wall;
- Quick and easy installation.

Main features:



3 storage zones



Document storage in compliance with GDPR 2018.



3-point locking mechanism



Solid powder-coated steel



Large shelf load capacity - 50 kg



6 year warranty

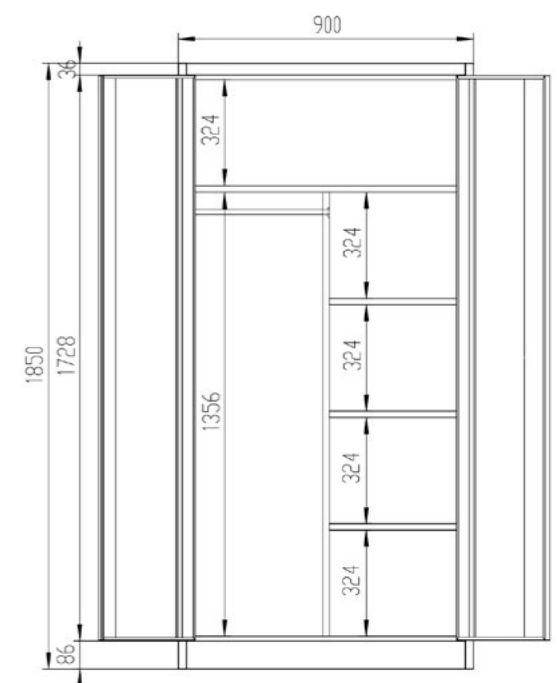
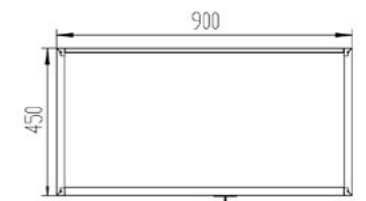

Model: IGOR



Our compact social cabinet is the perfect solution to the lack of space in social rooms. With its dimensions and amazing packing capacity of 6 cabinets, the IGOR model is perfect for small spaces. Igor cabinet is made of high-quality powder-coated steel. It is extremely resistant to mechanical damage, which is especially important in the case of a constantly used employee cabinet.

Description

Size: 1850x900x450mm

Cabinet weight: 49 kg

Material: Powder coated steel

Steel thickness: 0,6 mm

Package dimensions: 195x99x8,5 cm

Warranty: 6 years

Dimensions of the locker: Height: 84 cm
Width: 23 cm
Depth: 42 cm

Certificate: PZH

Colours:

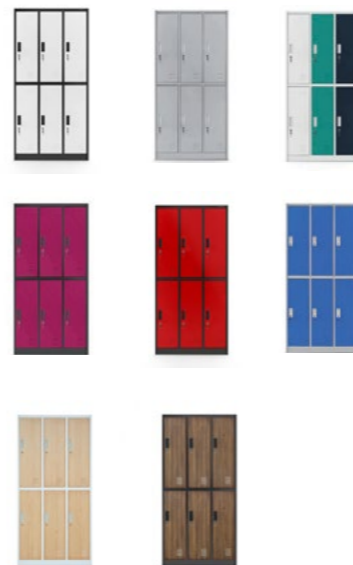

For which rooms:

 Schools, kindergartens, nurseries

 Gyms, swimming pools, fitness clubs

 Doctor's offices, beauty salons







 Home office

 Social rooms

Advantages of IGOR closet:

- Six capacious lockers that will allow you to store clothes, shoes, tools, personal items, as well as documents;
- The cabinet was made of thick steel sheet, which is distinguished by high resistance to mechanical damage - even at maximum load;
- Well-thought-out openings in the door provide excellent air circulation, facilitate preservation of freshness of stored clothes and prevent moisture accumulation;
- Thanks to a special place for a name label, each cabinet can be personalized, facilitating daily use;
- Functional bar allows you to hang up clothes and keep the inside of the cabinet in order;
- Simple, quick self-assembly.

Main features:

-  Capacious cabinets
-  Excellent ventilation
-  Secure lock
-  Space for business card holder
-  Clothes rail
-  High quality steel

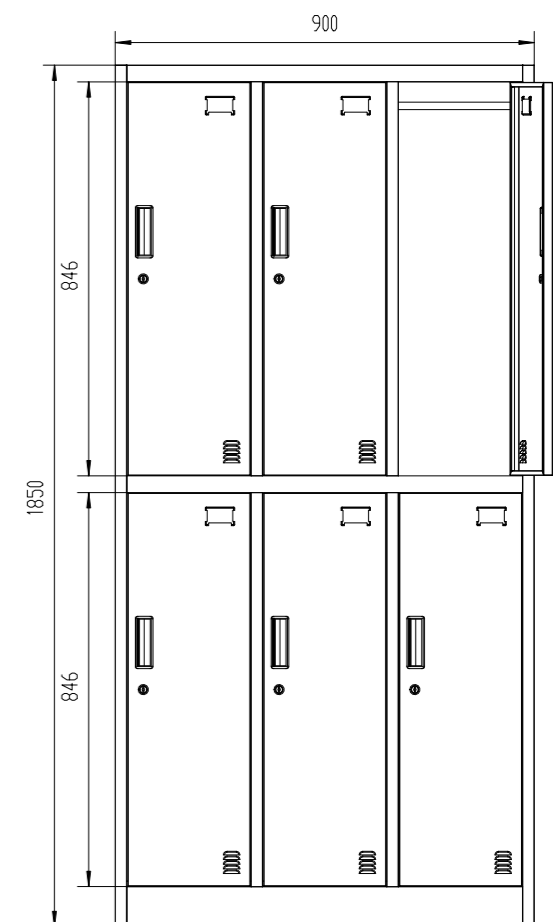
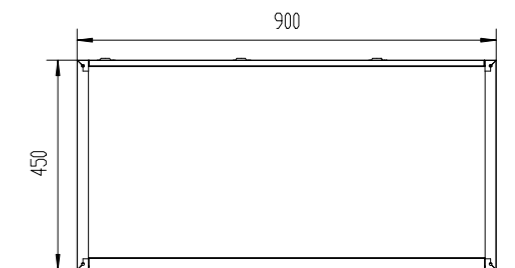

Model: IGOREK



The IGOREK metal school locker measures just 90 cm, but houses 6 spacious lockers. It is made of damage-resistant steel, which is coated with protective powder paint. Each compartment has a deadbolt lock, and special ventilation holes ensure adequate air circulation inside. Thanks to its compact dimensions, the IGOREK locker will work well even in small spaces in a school or sports facility.

Description

Size:	1500x900x450mm	Warranty:	6 years
Cabinet weight:	44 kg	Dimensions of the locker:	Height: 67 cm Width: 26 cm Depth: 42 cm
Material:	Powder coated steel	Certificate:	PZH
Steel thickness:	1,0/0,6 mm	Shelf load capacity:	85 kg
Package dimensions:	159,5x99,5x10 cm		

Colours:



For which rooms:

 Schools, kindergartens, nurseries

 Gyms, swimming pools, fitness clubs

 Doctors' offices, clinics





 Home office

 Social rooms

Advantages of IGOREK closet:

- IGOREK model at a width of only 90 cm offers as many as 6 capacious school lockers, making it suitable for small spaces;
- The small height of the cabinet of 150 cm means that the upper lockers can also be used comfortably by children;
- Made of 0.6 mm thick steel. Powder coating protects against scratches, corrosion and makes it easy to keep clean;
- The lockers are secured with a solid, bolted lock to protect the items inside;
- Each locker has a practical shelf that allows you to separate your shoes from your clothes, as well as a bar for hanging, for example, a jacket;
- Ventilation holes ensure adequate air circulation and optimal conditions for storing items;
- A prepared place for a business card holder makes it easier for users to find their stash;
- A universal key is included. In emergency situations, such as when users lose their key, any locker can be opened with it;
- Easy installation with the included clear instructions;

Main features:

-  Height suitable for the youngest.
-  Bar and shelf in each locker.
-  Master key
-  Powder-coated steel
-  6-year warranty



Model: JULIA



JULIA is a reliable social cabinet, with which the storage of even the most valuable items becomes safe and convenient. This sturdy model was created from strong powder-coated steel sheet, which provides the structure with strength and resistance to damage. Julia has only 80 cm in width, but guarantees plenty of storage space for four people.

Description

Size:	1850x800x450mm	Warranty:	6 years
Cabinet weight:	46 kg	Certificate:	PZH
Material:	Powder coated steel	Package dimensions:	195x55x15 cm
Steel thickness:	0,6 mm		

Colours:



For which rooms:

 Schools, kindergartens, nurseries

 Gyms, swimming pools, fitness clubs





 Workshops, warehouses

 Hospitals, hotels

Advantages of the JULIA closet:

- Universal, elegant color scheme that will work perfectly in any interior and allow you to create a set with other closets from the Jan Nowak offer;
- Large strength of shelves allows you to store clothes, shoes or personal items weighing up to 50 kg in each locker;
- Practical hanger rods make it easier to maintain order inside the closet and allow you to collect and separate things in a hygienic way;
- Strong lock prevents unauthorized people from opening the door, well protecting the stored contents;
- Collected items are protected from moisture by special ventilation holes, located in each cabinet;
- Our social cabinet meets the standards of GDPR 2018 - if necessary, it will store documents containing personal data in accordance with the current legislation;
- Self-assembly of Julia is quick and easy.

Main features:

-  Plenty of storage space
-  Master Key
-  Compact design
-  Made of strong steel
-  Rods for hanging clothes

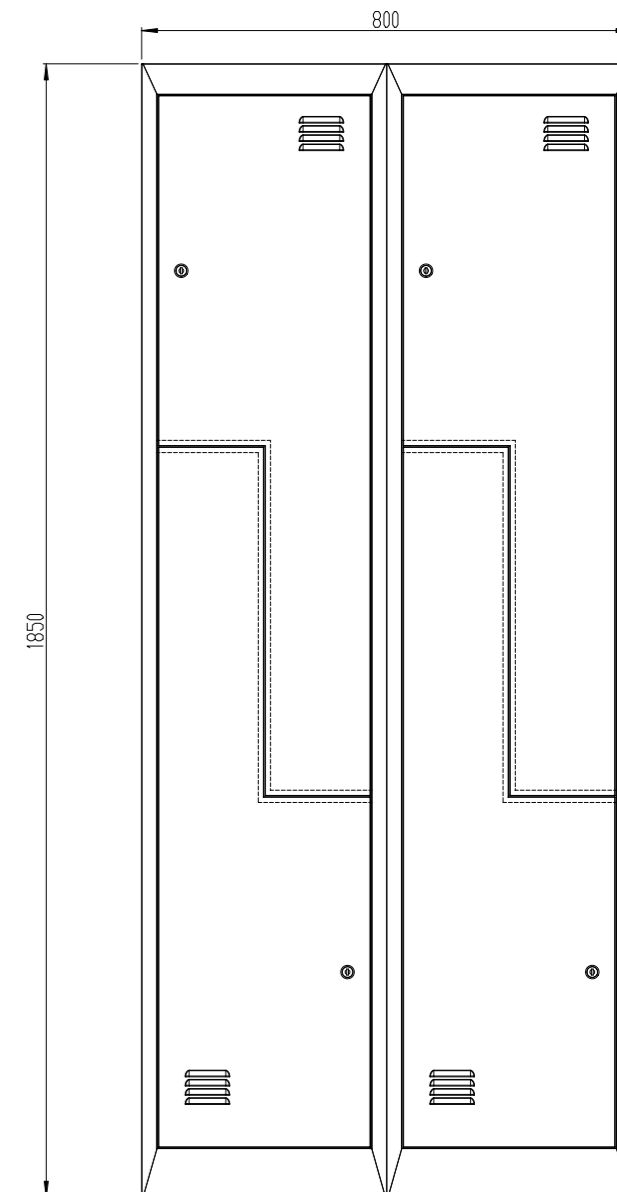

Model: KACPER



Colours:





KACPER is a well-designed and practical social closet, which will be ideal wherever employees change into work wear. The interior of the KACPER closet has been laid out with the best functionality and ease of maintaining order in mind. Four compartments (2 for each employee), rods and clothing hooks provide adequate space for employees' personal belongings and clothing. The locker is sturdy and very durable.

Description

Size:	1800x800x500mm	Warranty:	6 years
Cabinet weight:	50 kg	Certificate:	PZH
Material:	Powder coated steel	Package dimensions:	189,5x59x14,5 cm
Steel thickness:	0,6 mm		

For which rooms:

 Schools, kindergartens, nurseries

 Gyms, swimming pools, fitness clubs

 Workshops, warehouses





 Uniformed services

 Clinics, hospitals, laboratories, doctors' offices

Advantages of KACPER locker:

- Separation of business and private clothes increases the comfort of employees and has a positive effect on keeping clothes clean;
- Capacious interior is designed to store clothes and personal belongings as conveniently as possible: 4 compartments (2 for each employee), 2 shelves (including one for shoes), bar, clothes hooks;
- Holes in the door provide adequate ventilation of the interior, so it helps to maintain the freshness of the stored clothes and prevents the accumulation of moisture;
- Thanks to a special place for a name label, each cabinet can be personalized;
- The cabinet is made of thick steel sheet, which is distinguished by its high resistance to mechanical damage;
- Simple, quick self-assembly.

Main features:

-  Separation of private and business clothes
-  Master Key
-  Clothes rod for hanging up clothes
-  Excellent ventilation
-  Personalization of the cabinet

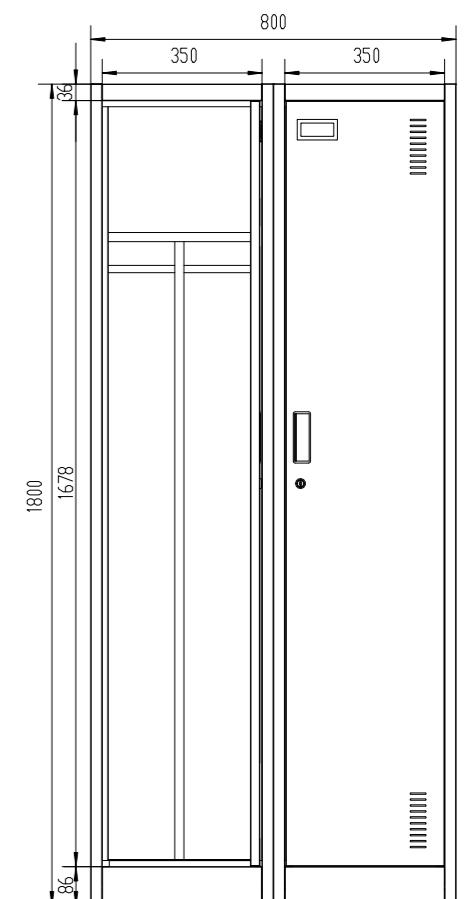
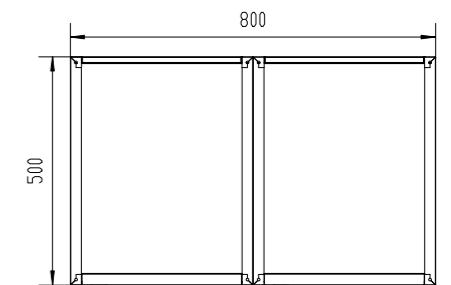

Model: KACPER II



A closet cabinet must be practical, capacious and safe to use - exactly like the KACPER II model! Our metal closet is the perfect solution for any type of locker room, because thanks to its carefully designed construction and practical interior, it will provide comfort and safe storage for employees or customers every day. KACPER II will allow you to accumulate and separate clean or dirty clothes, shoes, tools or personal items.

Description

Size:	1800x600x500mm	Warranty:	6 years
Cabinet weight:	45 kg	Certificate:	PZH
Material:	Powder coated steel	Package dimensions:	187,5x59x13,5 cm
Steel thickness:	0,6 mm		

Colours:





For which rooms:

 Schools, universities

 Gyms, swimming pools, fitness clubs

 Garages







 Hotels, hospitals

 Doctor's offices, clinics

Advantages of KACPER II closet::

- Each of the two compartments of our closet has a shelf, a bar for hangers, as many as four hooks for clothes and a special hanger that helps, for example, to separate clean clothes from dirty ones. So much functionality in one cabinet!
- KACPER II is an inconspicuous model - it is only 60 cm wide, so it will work well even in small checkrooms, but the carefully designed structure provides an exceptionally large amount of storage space;
- A strong lock effectively protects the stored contents from unauthorized access, which allows you to store not only clothes, shoes or tools, but also valuable personal items in the cabinet;
- Robust construction ensures that KACPER II is safe to use and always stands firmly;
- On the door of each locker there is a practical business card holder, thanks to which, if necessary, you can personalize the cabinets;
- Simple, quick self-assembly.

Main features:

-  Two capacious niches
-  Practical bar for hangers
-  Hooks for clothes
-  Space for a business card holder
-  Shelf in each cabinet
-  Clothes separating hook

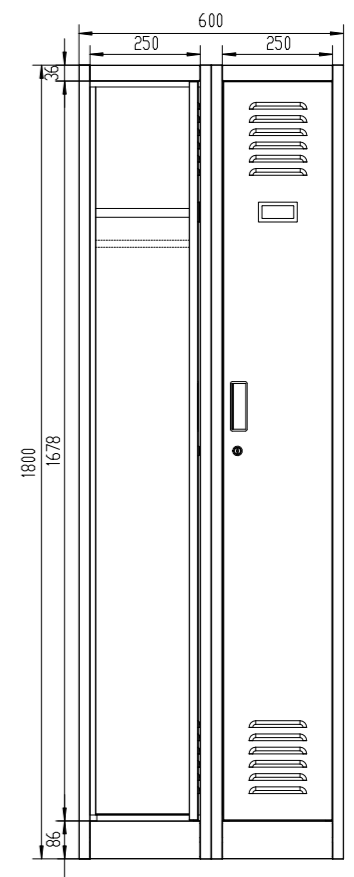
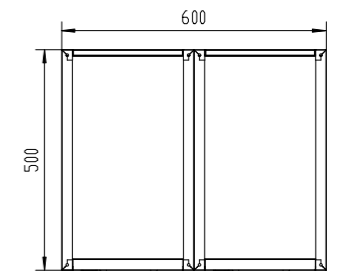

Model: KACPER II PRO



KACPER II PRO is a sturdy closet cabinet designed for locker rooms. The narrow 60 cm wide body contains two lockers with a separate lock. The interior of the compartments contains a convenient shelf, a bar for hanging clothes and 4 hooks. The locker is additionally equipped with an integrated bench for easy changing and a canopy, which improves cleanliness. The clothes locker will be great for school, pool or gym.

Description

Size:	2295x600x850 mm	Warranty:	6 years
Cabinet weight:	54,4 kg	Certificate:	PZH
Material:	Powder coated steel	Package dimensions:	175x60x14 cm 93x69,5x8 cm
Steel thickness:	1,0/0,6 mm		
Shelf load capacity:	85 kg		

Colours:



For which rooms:

 School locker rooms

 Swimming pool checkrooms







 Sports locker rooms

 Employee checkrooms, social rooms

Advantages of KACPER II PRO locker:

- Thoughtful design includes two separate lockers and a bench to streamline changing;
- The width of the locker is only 60 cm, so the required number of lockers can be accommodated in a small space;
- The closet locker is made of sturdy 0.6 mm thick steel. The metal parts are coated with powder paint, which protects against damage and makes it easy to clean;
- Efficient organization is ensured by the well-thought-out interior of the lockers, with a top shelf for a hat or bag, a rod for hanging clothes, a dedicated space for shoes and additional hooks on the side walls;
- Each locker is secured with a lock to protect the items inside and includes two sets of keys;
- A business card slot on the front of the cabinet helps users find their locker;
- A canopy on top of the locker improves its aesthetics, makes it easier to wipe away dust and prevents items from being deposited on it, so nothing will fall on users' heads;
- Factory holes allow the locker to be attached to the wall, increasing its stability.

Main features:

-  Two compartments with separate doors.
-  Top shelf, bar.
-  Sturdy bench
-  Canopy
-  Powder-coated steel
-  6-year warranty

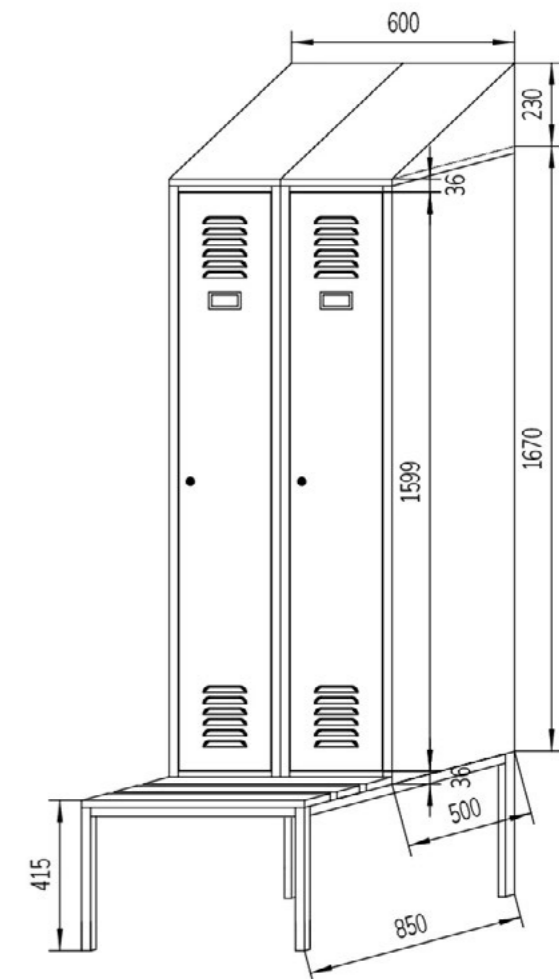

Model: KAROL



KAROL is a cabinet with lockable 18 lockers. It offers an excellent ratio of external dimensions to the number of cabinets, as well as their packing capacity. This makes it ideal for the social rooms of large companies or public places. In addition, the small depth makes it possible to place it even in a narrow corridor.

Description

Size:	1850x900x400 mm	Dimensions of the locker:	258x266x362 mm
Cabinet weight:	54 kg	Certificate:	PZH
Material:	Powder coated steel	Package dimensions:	194x99,5x10 cm
Steel thickness:	0,6 mm		

Colours:



For which rooms:



School locker rooms, kindergartens



Businesses, manufacturing plants, warehouses



Gyms, fitness clubs, swimming pools



Bowling alleys, libraries, museums



Police stations and police headquarters, municipal police stations



Shopping malls, stores

Advantages of KAROL cabinet:

- The closet of small size holds as many as 18 storage compartments. By placing several cabinets side by side, you will easily manage to provide the necessary number of lockers in the room;
- The locker can accommodate small items: shoes, phone, wallet, a meal for work, books, documents, small purchases;
- The locker is only 40 cm deep, so it can be placed even in a narrow hallway;
- Ventilation holes keep stored items fresh and in great condition;
- Each door has a place for a business card holder, which will make it easier for users to find their cabinet;
- The 0.6 mm thick steel construction is sturdy and durable. Even with heavy use, it remains in perfect condition for years. In addition, its cleaning does not require much effort;
- Each cabinet comes with two keys included. A spare copy will allow you to get inside if the user loses or forgets their key. It also allows you to inspect the contents of the cabinet if necessary;
- Simple, quick self-assembly.

Main features:

-  18 storage compartments
-  Sturdy construction
-  Business card holder on each door.
-  Ventilation provided
-  Spare key for each cabinet
-  6 year warranty

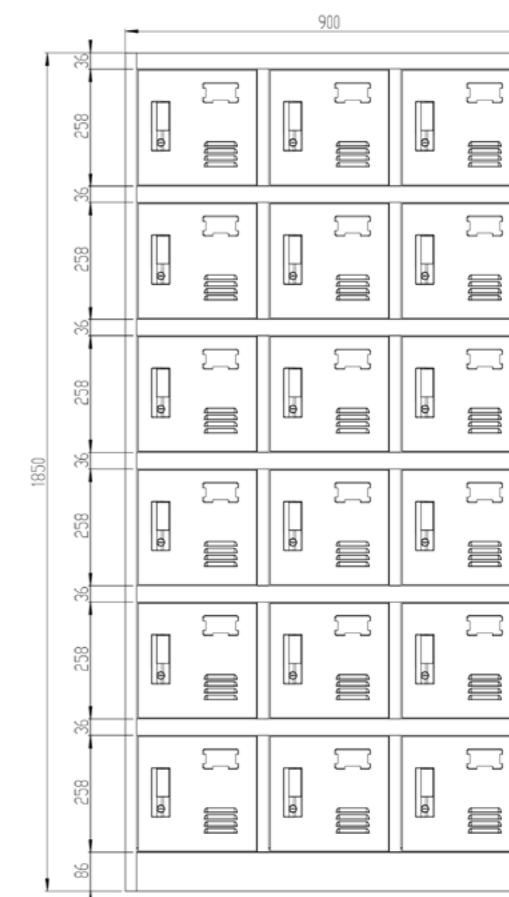

Model: MARCIN



Model Marcin is a locker cabinet with great proportions and a large number of packed lockers. Each of the 12 storage compartments is lockable, has ventilation and a business card holder, so users can rest assured about the contents inside. The dimensions of the cabinet have been chosen to fit both narrow corridors and spacious rooms.

Description

Size:	1850x900x400 mm	Dimensions of the locker:	400x260x360 mm
Cabinet weight:	49 kg	Certificate:	PZH
Material:	Powder coated steel	Package dimensions:	194x99x10 cm
Steel thickness:	0,6 mm		

Colours:



For which rooms:



School locker rooms, kindergartens



Businesses, manufacturing plants, warehouses



Gyms, fitness clubs, swimming pools



Bowling alleys, libraries, museums



Police stations and police headquarters, municipal police stations



Shopping malls, stores

Advantages of MARCIN cabinet:

- The compact size accommodates up to 12 storage compartments. The 90 cm width of the cabinet will allow you to place several units in the room side by side and thus achieve the required number of lockers;
- The dimensions of a single locker have been selected to accommodate medium-sized items inside: shoes, bag, backpack, a meal for work, books, documents, small purchases;
- The locker is only 40 cm deep, so it can be placed even in a narrow hallway;
- Items stored inside stay fresh because each locker has ventilation holes;
- Business card holders located on the door will make it easier for users to find their stash quickly;
- The 0.6 mm thick steel construction is sturdy and durable. Even with heavy use, it remains in great shape for years;
- Dirt from the surface is removed very easily, which is extremely important when the locker is located in public places;
- A spare key for each cabinet. It will allow you to get inside if the user loses or forgets their key. It also allows you to check the contents of the cabinet;
- Simple, quick self-assembly.

Main features:



12 storage compartments



Sturdy construction



Business card holder on each door



Ventilation provided



Spare key for each cabinet



6 year warranty

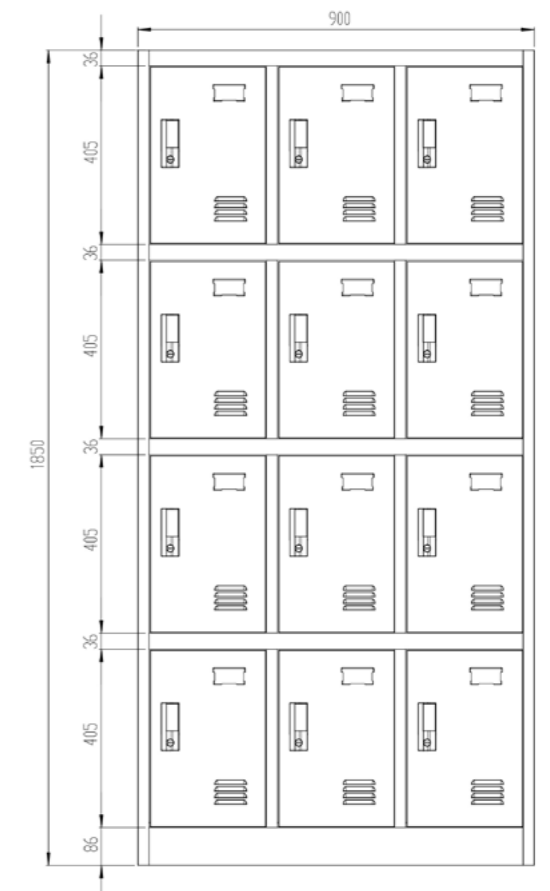

Model: OLA



Colours:





OLA is a social cabinet that brings energy and freshness to the interior. Thanks to its colors, dimensions and solid workmanship, it will prove useful mainly in schools, nurseries and kindergartens, that is, where durability, quality and compactness are required of furniture. Toddlers will be happy to store their belongings in OLA, and the solid construction will perfectly take care of their safety.

Description

Size:	1200x1090x450mm	Warranty:	6 years
Cabinet weight:	45 kg	Dimensions of the locker:	240x320x450 mm
Material:	Powder coated steel	Certificate:	PZH
Steel thickness:	0,6 mm		
Package dimensions:	129x119x11 cm		

For which rooms:

 Schools, kindergartens, nurseries

 Gyms, swimming pools, fitness clubs





 Doctors' offices, beauty salons

 Stores, shopping malls

Advantages of OLA closet:

- Classic design and distinctive colors make the cabinet look exceptionally original;
- Robust construction of thick steel sheet makes OLA durable, resistant to exploitation and safe to use;
- Compact dimensions let OLA equip both large and small rooms, while storing personal belongings of up to twelve people;
- Strong locks protect the stored contents from unauthorized access, allowing you to store even valuable items such as phone, keys or wallet in the cabinet;
- Holes in the back wall allow the closet to be attached to the wall, effectively increasing security;
- Ventilation holes ensure air circulation inside the cabinets, so OLA guarantees the necessary air circulation and takes care of the stored contents;
- Quick, intuitive installation.

Main features:

-  Unique design
-  Robust construction made of 0.6 mm steel
-  Reliable, interlocked locks
-  Compact dimensions - large capacity
-  GDPR compliant

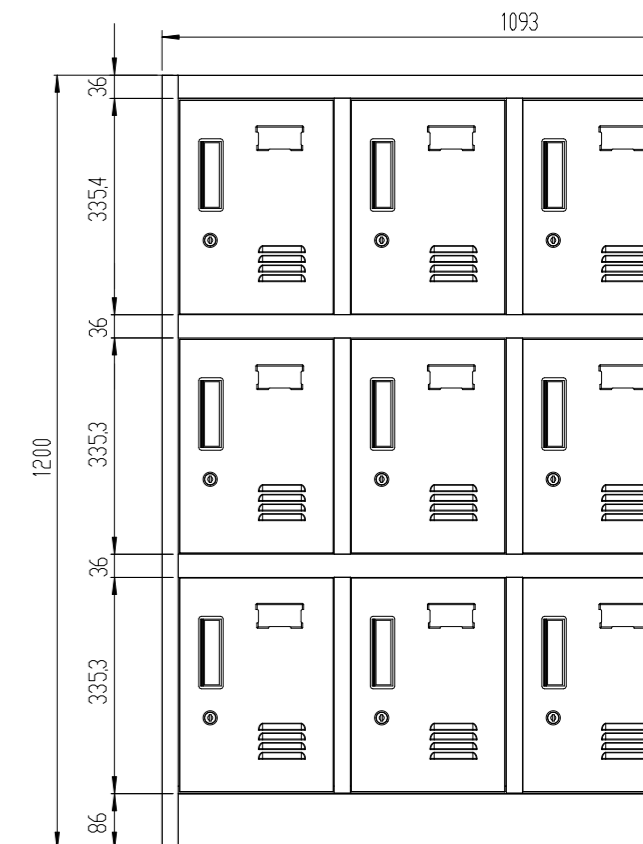

Model: OLIVER



Model Oliver is a multi functional, perfectly organized storage cabinet, with which the daily storage of essential items or groceries will become easy and comfortable. Thanks to the compact dimensions of the lockers, the small cabinet managed to fit as many as 33 lockers. Each of them is equipped with a strong, bolted lock, an air vent and a business card holder.

Description

Size:	1850x900x400 mm	Dimensions of the locker:	130x220x42 mm
Cabinet weight:	71 kg	Certificate:	PZH
Material:	Powder coated steel	Package dimensions:	194,5x99,5x12,5 cm
Steel thickness:	0,6 mm		

Colours:



For which rooms:



Offices



Police stations and police headquarters, municipal police stations



Canteens, social rooms



Businesses, factories, warehouses



Hotels, spa salons

Advantages of OLIVER cabinet:

- The tall locker cabinet managed to accommodate 33 separately keyed lockers;
- The interior of a single locker will accommodate wallet, phone, correspondence, documents, work meal, shoes, bag, backpack, work meal, books, small purchases;
- The cabinets have air vents that provide adequate air circulation. They allow to maintain adequate humidity and the persistence of unpleasant odors inside;
- The cabinet is strong and sturdy, thanks to the use of strong 0,6 mm thick steel sheet and protected by powder paint (protection against corrosion). It will maintain excellent condition for many years;
- The materials used contribute to easy cleaning both outside and inside. This makes the model suitable even in demanding public spaces;
- A spare key for each cabinet. It will allow access to the cabinet when the user loses or forgets their key. It also allows you to check the contents of the cabinet;
- Simple, quick self-assembly.



Main features:



33 storage compartments



Sturdy construction



Business card holder on each door.



Ventilation provided



Spare key for each cabinet



6 year warranty

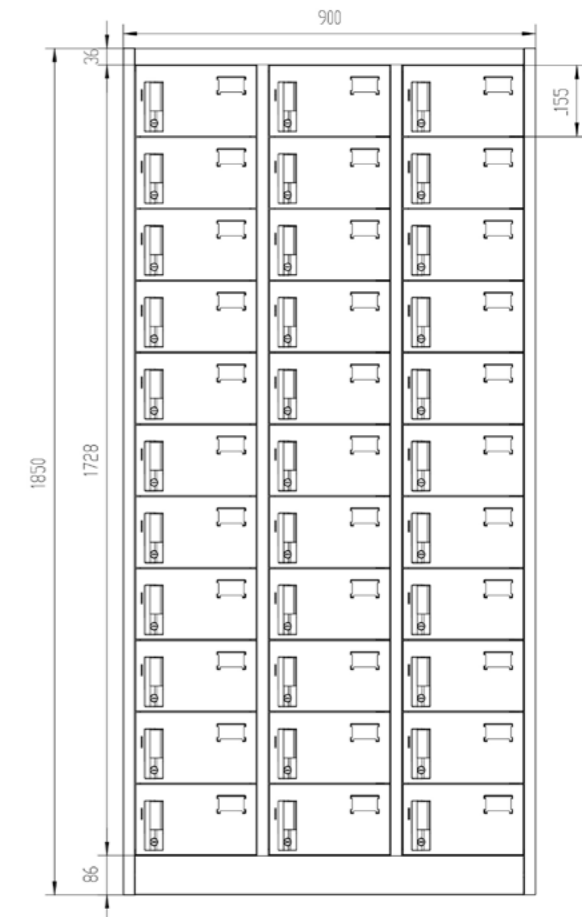

Model: ROBERT

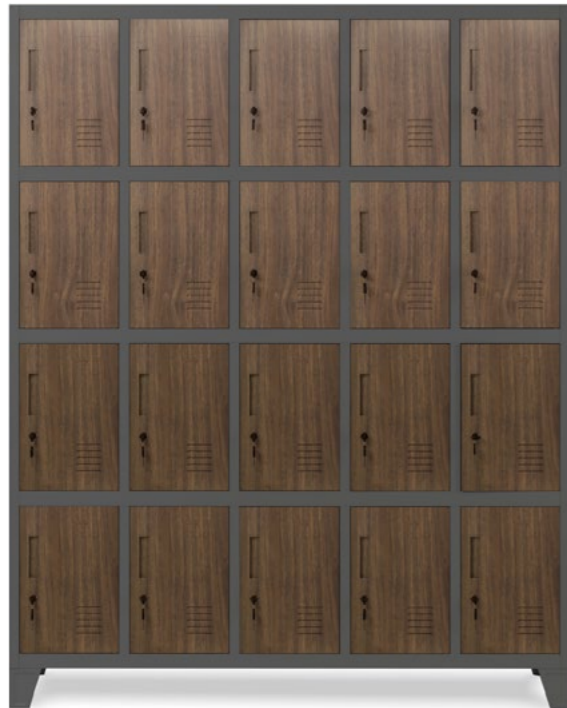

Model Robert is a locker cabinet with a great ratio of external dimensions to the number of lockers. Measuring only 136 cm wide, 172 cm high and 45 cm deep, it accommodates as many as 20 separately lockable storage compartments. Sturdy lock, vents and business card holders guarantee comfortable storage in the workplace, library, swimming pool, kindergarten. The cabinet has the option of mounting on legs, which increase its aesthetics.

Description

Size:	1720x1260x450 mm	Dimensions of the locker:	360x240x450 mm
Cabinet weight:	73,5 kg	Certificate:	PZH
Material:	Powder coated steel	Package dimensions:	171x145,5x9 cm
Steel thickness:	0,6 mm		

Colours:

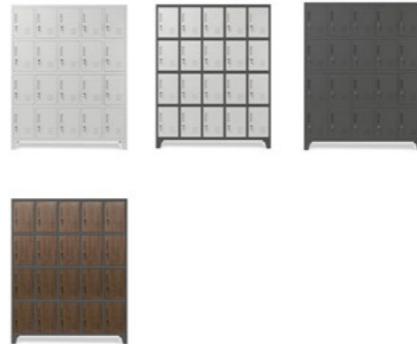

For which rooms:



Police stations and police headquarters, municipal police stations.



School locker rooms, kindergartens



Businesses, factories, warehouses



Gyms, fitness clubs, swimming pools



Bowling alleys, libraries

Advantages of ROBERT cabinet:

- A multi-purpose model that offers as many as 20 storage compartments locked with separate locks in a compact size;
- The interior of a single locker will accommodate shoes, a bag, a backpack, a meal for work, books, small purchases;
- For the utmost comfort of users, each locker is equipped with ventilation holes and a business card holder;
- Sturdy construction is made of powder-coated 0.6 mm thick steel sheet, which means the locker will maintain excellent condition even under heavy use;
- Easy to keep clean and hygienic. The model is perfect for public spaces;
- Spare key for each locker. It will allow you to get inside if the user loses or forgets their key. It also allows you to control the contents of the cabinet;
- Ability to mount the furniture on legs. It will facilitate access to the lowest level of cabinets, and will also allow you to keep the floor in perfect order;
- Simple, quick, self-assembly.

Main features:



20 storage compartments



Sturdy construction



Business card holder on each door.



Ventilation provided



Spare key for each cabinet



6 year warranty

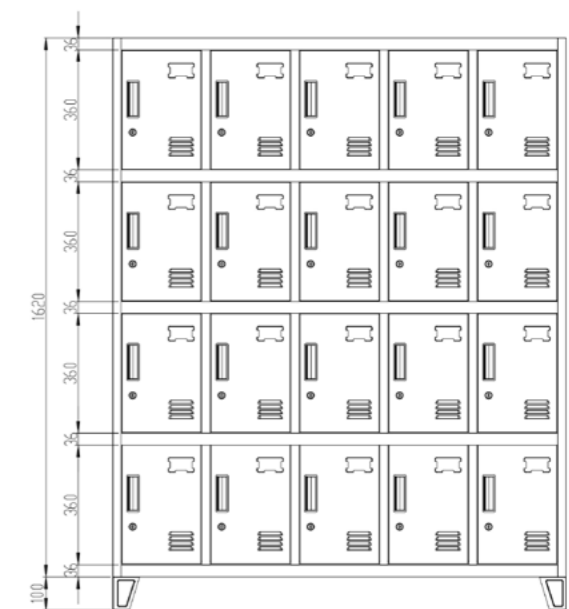

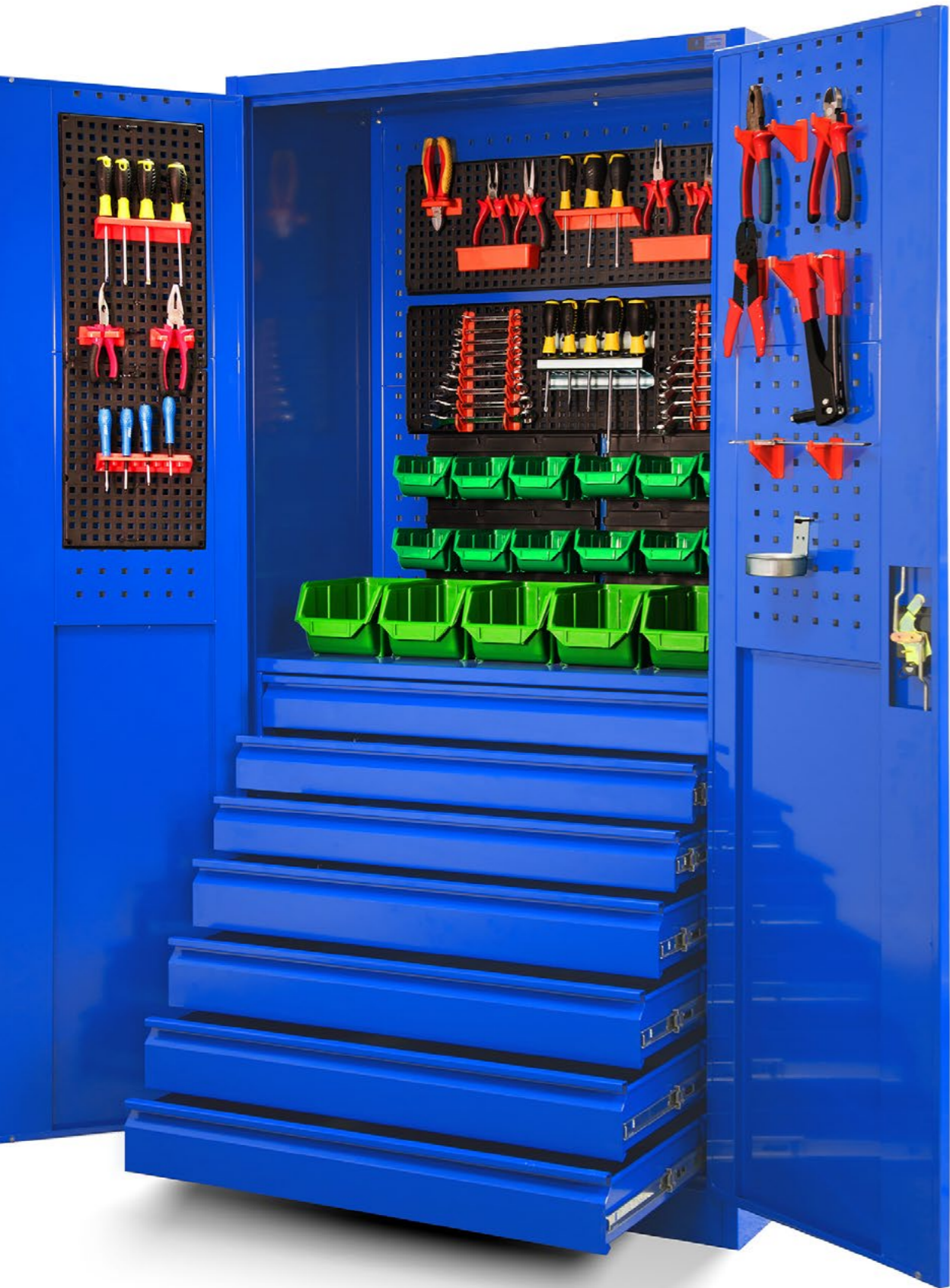

Workshop Furniture

 Jan Nowak®

Model: BEN

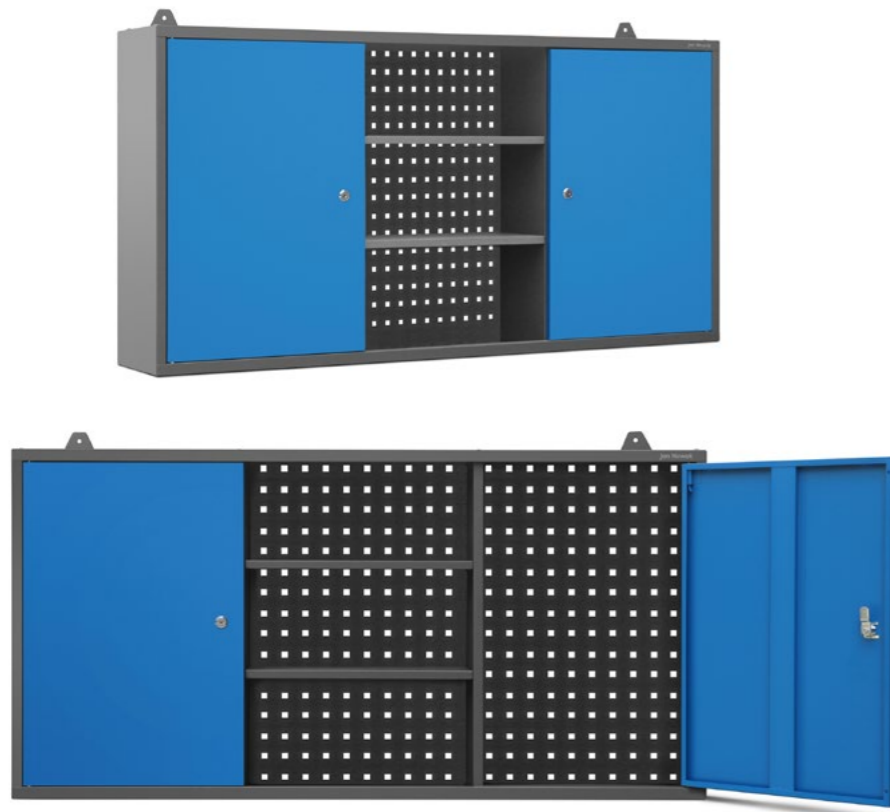

The BEN narrow hanging cabinet is a great addition to your workshop, plant or garage space. The cabinet's design is divided into three storage zones. Two lockable compartments are divided by an open recess with shelves. The perforated board located at the back will make it easier to organize tools and keep things in order. BEN is a model with compact dimensions (120x60x20 cm), which is perfect for smaller spaces.

Description

Size:	1200x600x200 mm	Maximum load:	40 kg
Weight of the cabinet:	17 kg	Perforated board hole diameter:	5 mm
Material:	Powder coated steel	Distance between holes of perforated board:	10 mm
Steel thickness:	0,8 mm		
Package dimensions:	127,5x48,5x5,5 cm		

Colours:

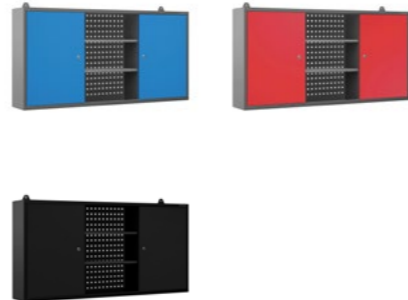

For which rooms:



Craft workshops, vulcanization plants



Garages



Backyard workshops



Construction companies









Automotive workshops

Advantages of BEN wall cabinet:

- Division into three storage zones - two lockable cabinets and one open recess. This is a proven way to store tools conveniently;
- Lockable cabinets allow you to assign access to the interior only to selected people. This is a good place to store more valuable tools or documents;
- The perforated board located along the entire length of the cabinet will allow great management of the inside of the cabinet. This will avoid clutter and provide easy access to all items;
- Powder-coated steel components are well protected against damage and rust. The even coating of the varnish and well-chosen colors significantly affect the aesthetics of the cabinet and create a matching set of workshop furniture;
- The load capacity of the cabinet is up to 40 kg, but when loading the furniture, take into account the method of installation and the strength of the wall;
- Perfectly sized, the cabinet is both packable and space-saving. The depth is only 20 cm, so it will not impede movement in narrow rooms;
- Intuitive and quick installation.

Main features:

-  Three storage zones
-  2 lockable cabinets.
-  2 shelves
-  Tool board
-  Powder-coated steel
-  Compact dimensions
-  6-year warranty

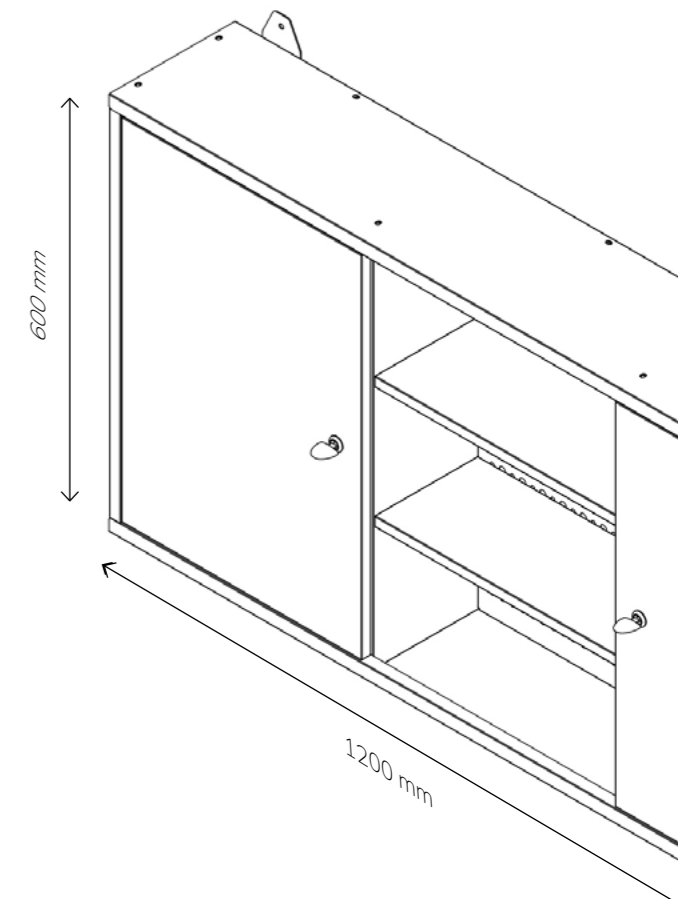

Model: BRUNO



Workshop and tool cabinet BRUNO is a model that will be perfect for any place where a sturdy, massive and well-thought-out piece of furniture for storing tools is necessary. 4 adjustable shelves with a load capacity of up to 80 kg after installation allow you to get niches of a size perfectly suited to the stored things. The cabinet is also equipped with perforated panels, on which you can install handles and hooks and thus arrange tools in any way you want.

Description

Size:	1850x920x500mm	Material:	powder coated steel
Cabinet weight:	71kg	Steel thickness:	0,8 mm
Cabinet weight:	80kg	Warranty:	6 years
Package dimensions:	194x110x10 cm	Certificate:	PZH

Colours:

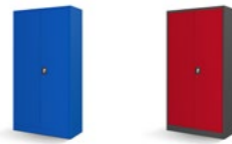

For which rooms:



Automotive workshops, manufacturing plants, warehouses



Premises of fire departments



Police stations and police headquarters, municipal police stations



Craft workshops, construction companies



Household workshops, garages

Advantages of BRUNO cabinet:

- BRUNO has 4 solid shelves that can withstand a load of up to 80 kg;
- The height of the shelves can be adjusted in 25 mm increments to adjust the interior of the cabinet to suit your needs;
- Perforated walls, on which you can hang hooks, handles, give you the opportunity to arrange tools to your own preferences;
- A strong 3-point lock protects the contents of the cabinet and prevents unauthorized access to tools;
- Full opening range of the door allows easier access to the contents of the cabinet;
- Reinforced doors and solid body made of thick steel guarantee the stability and high durability of the cabinet;
- The metal structure of the cabinet is easy to keep clean and can be disinfected;
- Simple, quick installation.

Main features:



Board perforated in 3 places



3-point lock to secure contents



Robust and stable construction



Adjustable shelves in 25mm increments

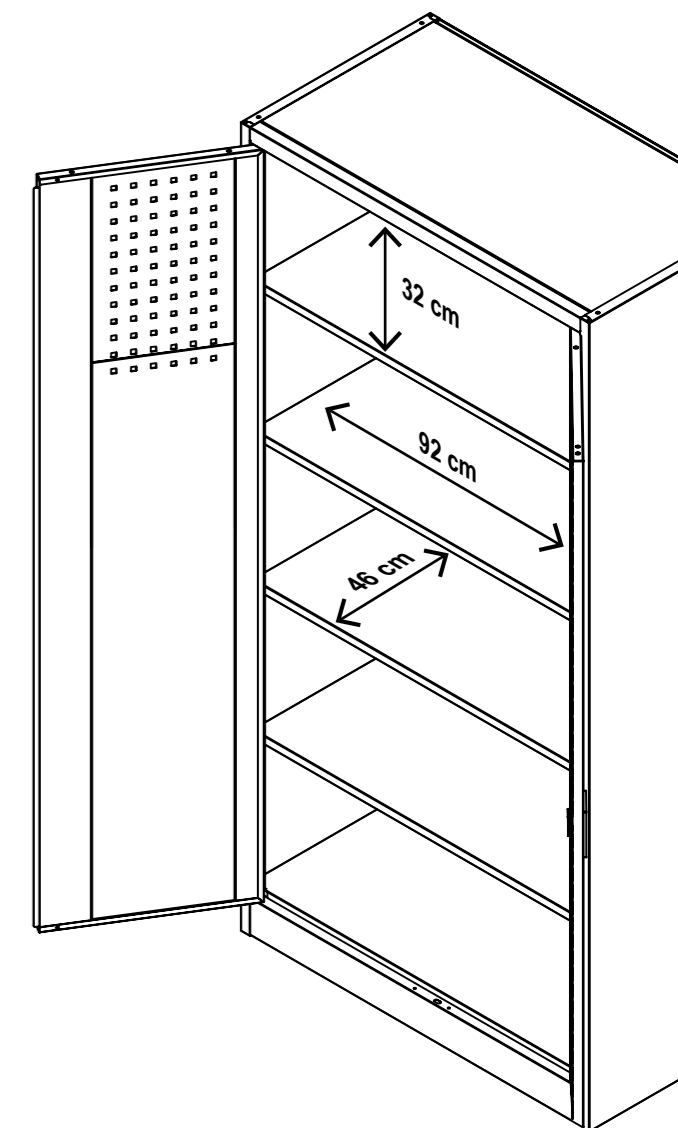

Model: DAREK



Colours:



With the DAREK workshop cabinet, storing tools is a snap! The model has a capacious niche with a perforated wall and 7 deep drawers - the functional interior of the cabinet allows you to maintain order and easy access to stored tools. The perforation inside allows you to place hooks and handles inside the cabinet, necessary for storing tools. Robust construction and double-leaf doors closed with a bolted lock provide the required security.

Description

Size:	1850x920x500 mm	Distance between holes of perforated board:	27 mm
Cabinet weight:	138 kg	Dimensions of perforated board holes:	10x10 mm
Material:	Powder coated steel	Load capacity of one drawer:	40 kg
Steel thickness:	1,1 mm	Certificate:	PZH
Package dimensions:	194x109x10 cm 84,5x50x28 cm 84x50x44,5 cm		

For which rooms:



Automotive workshops, manufacturing plants, warehouses



Craft workshops, construction companies



Household workshops, garages



Premises of fire departments



Police stations and police headquarters, municipal police stations

Advantages of DAREK cabinet:

- The workshop cabinet is extremely durable, resistant to damage and always remains stable. It weighs as much as 138 kg, because it was made of solid steel sheet 1.1 mm thick;
- Seven capacious drawers will make it easy to maintain order. Drawers will allow intuitive segregation of the collected contents. Smooth operation will be ensured by reliable, quiet slides;
- Perforated boards located in three places provide ample storage for tools. Items hung on the holders are always easily accessible;
- A 3-point lock prevents unauthorized people from opening the cabinet door;
- Reinforced doors and a solid body increase the strength of the cabinet and guarantee the safety of stored items or documents;
- The DAREK closet door not only protects the contents, but also facilitates access to drawers and alcoves during everyday use;
- The metal structure of the cabinet is easy to keep clean, it can be disinfected;

Main features:

- Robust and stable construction
- Board perforated in 3 places
- 7 capacious drawers
- 3-point lock to secure the contents
- Powder coated steel
- 6 year warranty

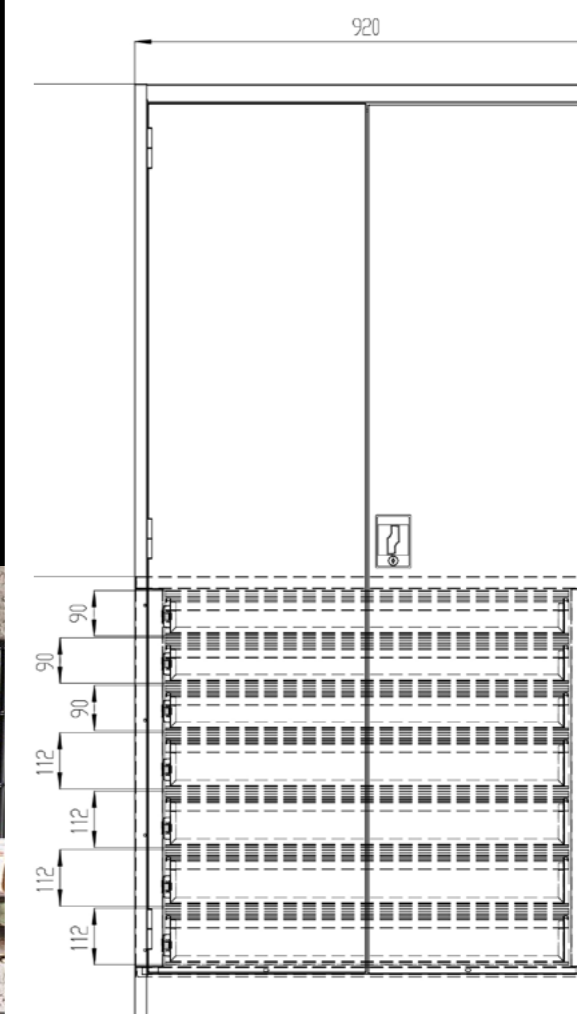

Model: ERIC



Colours:



ERIC workbench occupies a small area, but gives great comfort when doing small repairs. The minimalist yet very modern design consists of a laminated MDF top supported by a stable steel structure. Equipped with a drawer and shelves, it allows you to organize the necessary tools. You will organize all the nuts and bolts to perfection, while keeping them close at hand while you work. In addition, there are two open shelves under the top. Don't worry about running out of storage space.

Description

Size:	1200x850x600 mm	Maximum load:	Up to 400 kg
Weight of the cabinet:	48,8 kg	Permissible load:	Drawer 45 kg, shelf 50 kg
Package dimensions:	129,5x70x12 cm	Top:	30 mm thick laminated MDF board
Material:	Powder coated steel		

For which rooms:



Vulcanization shop, craft shop



Garage



Home workshop



Construction company



Car workshop

Advantages of ERIC workbench:

- Adjustable legs will allow you to level your garage furniture, even if your floor surface is not ideal;
- The solid 30 mm thick laminated MDF top of 60 × 120 cm has a light wood texture. It is extremely functional and resistant to damage;
- Powder-coated paint provides an additional layer of protection for the steel structure;
- ERIC is a workbench with a maximum load of up to 400 kg;
- The modern design is equipped with a capacious drawer and a lockable cabinet. The permissible load of the drawer is 45 kg, and the shelf is 50 kg;
- A choice of 3 colors will allow you to match the ERIC workbench with other JAN NOWAK workshop furniture, such as tool cabinets;
- The table was made of stainless steel, so it is resistant to damage;
- Simple, quick, self-assembly.

Main features:

- 1 drawer, 2 convenient shelves
- Lockable cabinet
- Strong MDF top
- Adjustable legs
- 3 color versions
- Load capacity up to 400 kg
- Modern look
- Powder coated stainless steel

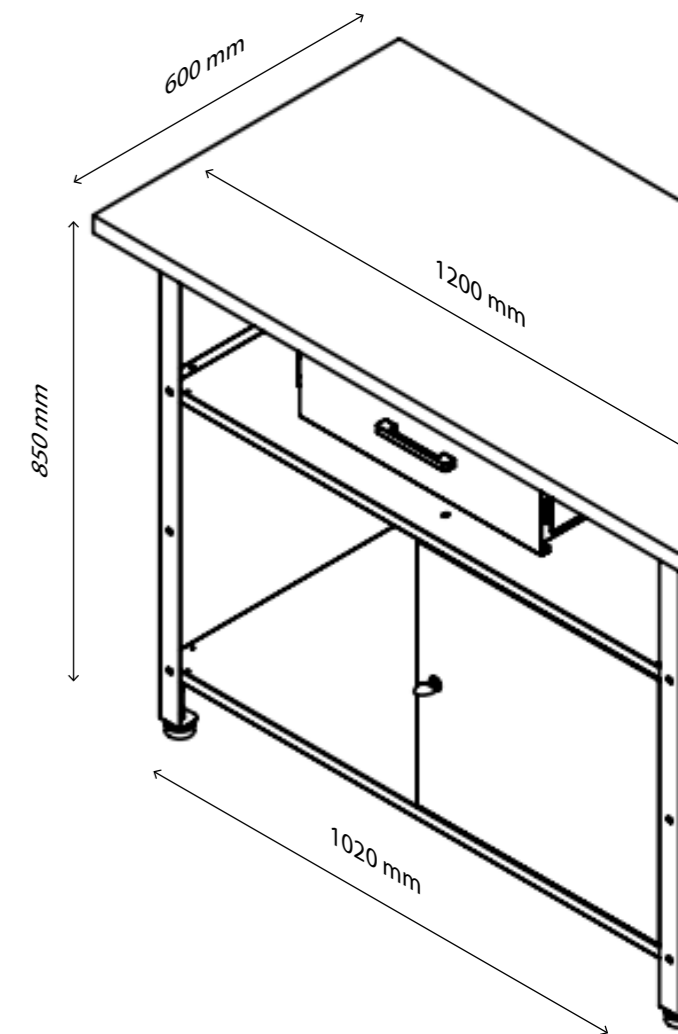

Model: FRANK



Colours:



ERIC workbench occupies a small area, but gives great comfort when doing small repairs. The minimalist yet very modern design consists of a laminated MDF top supported by a stable steel structure. Equipped with a drawer and shelves, it allows you to organize the necessary tools. You will organize all the nuts and bolts to perfection, while keeping them close at hand while you work. In addition, there are two open shelves under the top. Don't worry about running out of storage space.

Description

Size:	1700x850x600 mm	Maximum load:	Up to 500 kg
Weight of the cabinet:	91,5 kg	Permissible load:	Drawer 45 kg, shelf 50 kg
Package dimensions:	190x70x16,5 cm	Top:	30 mm thick laminated MDF board
Material:	Powder coated steel		

For which rooms:



Vulcanization shop, craft shop



Garage



Home workshop



Construction company



Car workshop

Advantages of FRANK workbench:

- Adjustable legs will allow you to level your garage furniture. Even when your floor surface is not ideal;
- The solid top made of 30 mm thick laminated MDF, measuring 60 × 170 cm, is extremely functional and resistant to damage;
- There is a gap in the middle of the table, so that you can easily slide to the work surface while sitting;
- Powder-coated paint provides an additional layer of protection for the steel structure;
- Thanks to the key locker you will safely store valuable tools;
- The modern design is equipped with 6 drawers and a lockable cabinet. The drawer load capacity is 45 kg, and the shelf load capacity is 50 kg;
- A choice of colors will allow you to match the ERIC workbench with other JAN NOWAK workshop furniture, such as tool cabinets;
- The table was made of stainless steel, so it is resistant to damage;
- Simple, quick, self-assembly.

Main features:

- 6 convenient drawers
- Lockable cabinet
- Strong MDF top
- Adjustable legs
- 3 color versions
- Load capacity up to 500 kg
- Modern look
- Powder coated stainless steel

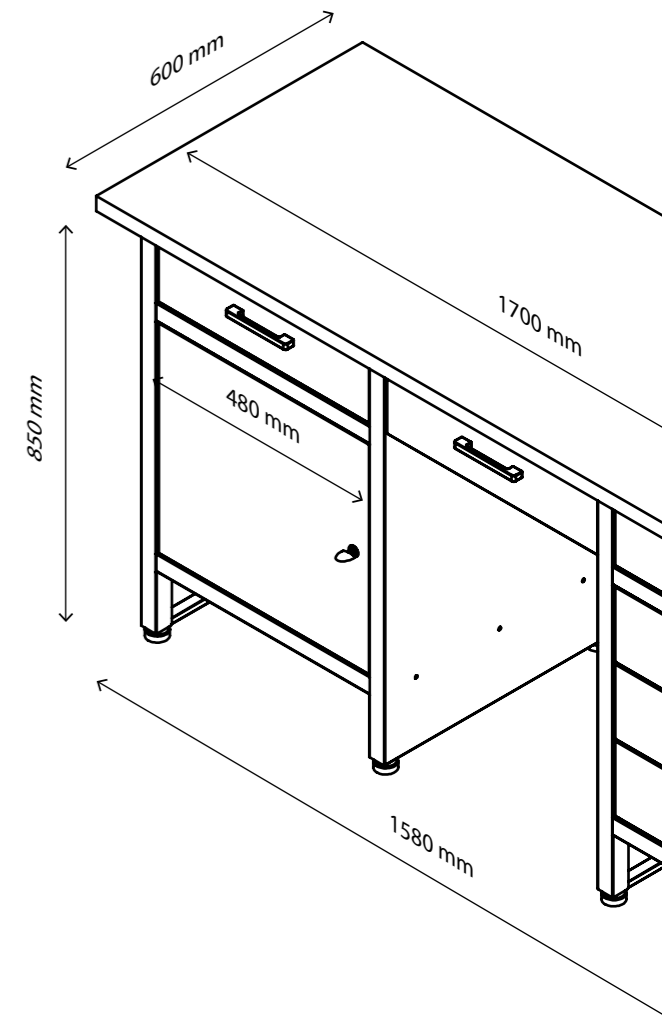

Model: HENRY



Colours:



If you lack a suitable place to work in your garage or workshop, we have a solution for you. The HENRY workbench will work well both in the garage and in a professional workshop. A very large working surface of the tabletop, plus capacious drawers and a lockable cabinet are the main features of this workbench. HENRY is characterized by a large working surface (60 × 170cm) and a high load capacity of up to 500 kg. The 30mm thick laminated MDF top provides high resistance to damage or abrasion. HENRY rests on adjustable legs that level out any unevenness.

Description

Size:	1700x850x600 mm	Maximum load:	Do 500 kg
Weight of the cabinet:	93,2 kg	Permissible load:	Drawer 45 kg, shelf 50 kg
Package dimensions:	179x70x13,5 cm	Top:	30 mm thick laminated MDF board
Material:	Powder coated steel		

For which rooms:



Home and professional workshop



Garage



Vulcanization shop, craftsman's shop



Construction company



Car workshop

Advantages of HENRY workbench:

- Adjustable legs will allow you to level your garage furniture. Even when the surface of your floor is not ideal;
- HENRY is equipped with 6 drawers and a spacious lockable cabinet;
- The drawer load capacity is 45 kg, and the shelf load capacity is 50 kg;
- The solid 30 mm thick laminated MDF top of 60 × 170 cm has a light wood texture. It is extremely functional and resistant to damage;
- Powder-coated paint provides an additional layer of protection for the steel structure.
- Thanks to the key locker you will safely store valuable tools;
- The choice of colors will allow you to match the ERIC workbench with other JAN NOWAK workshop furniture, such as tool cabinets;
- The table was made of stainless steel, so it is resistant to damage;
- Simple, quick self-assembly.

Main features:



6 convenient drawers



Lockable cabinet



Strong MDF top



Adjustable legs



Load capacity up to 500 kg



Modern look



Powder coated stainless steel

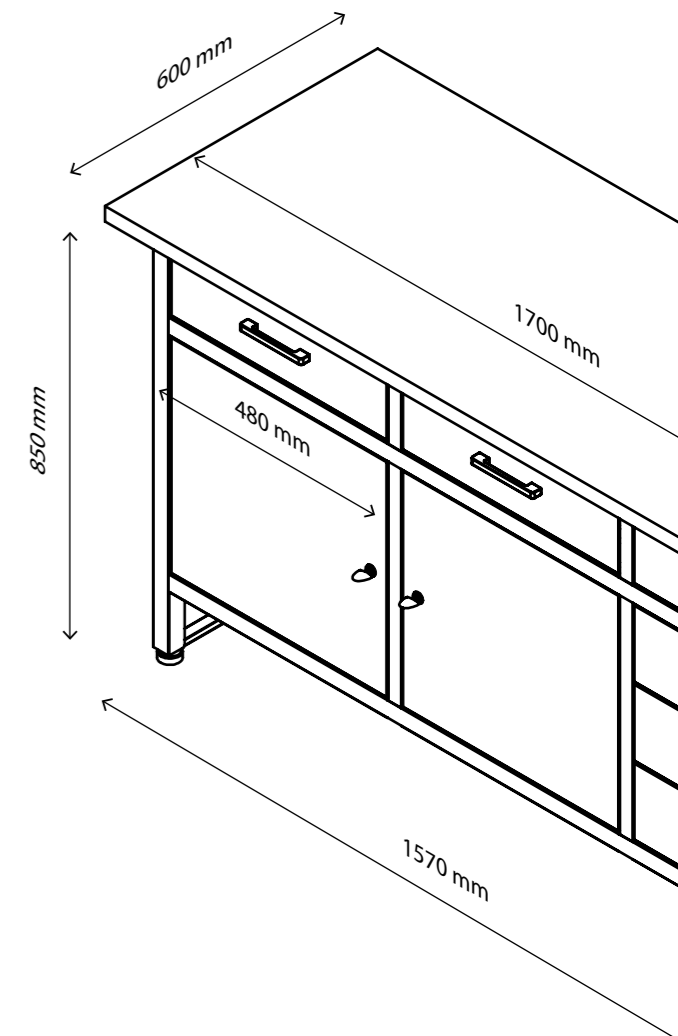

Model: HUGO



Colours:



Workshop tool trolley HUGO is a functional piece of furniture that makes the most necessary tools for work always at hand. It has three storage zones. Each of them is protected by a special rim, which prevents the objects on it from falling during movement. Allowing trouble-free movement, the casters, the construction of strong steel and small dimensions (70x78x40 cm) make the HUGO tool trolley an extremely useful element of any workshop, factory or garage.

Description

Size:	780x700x400 mm	Certificate:	PZH
Weight of the cart:	14 kg	Package dimensions:	79,5x50x17,5 cm
Material:	Powder coated steel		
Steel thickness:	1,1 mm / 0,8 mm		

For which rooms:



Automotive workshops, manufacturing plants, warehouses



Craft workshops, construction companies



Household workshops, garages



Premises of fire departments



Police stations and police headquarters, municipal police stations

Advantages of HUGO tool trolley:

- The strong structure is formed by two types of powder-coated steel - one with a thickness of 1.1 mm, from which the frame was made, and the other, forming the shelves of the cart, with a thickness of 0.8 mm. It makes the cart durable, sturdy and in great shape serves for many years;
- Suitably sized, the HUGO cart does not take up a lot of space, and thanks to three levels of storage it is able to hold really a lot. This is a great solution even for small rooms;
- The shelves, with a load capacity of up to 45 kg, are the perfect place for tools or accessories, such as screwdrivers or wrenches, which are necessary at the time of work;
- HUGO is equipped with high-quality casters that glide quietly and smoothly over any surface, even rough and uneven ones;
- A handy handle on the side of the cart allows you to move it comfortably from place to place, even with a heavy load.

Main features:

- ✓ Robust design
- ✓ Large load capacity
- ✓ Compact dimensions
- Quiet, maneuverable casters
- ✓ Handle for easy movement
- ✓ Powder coated steel
- ✓ 6-year warranty

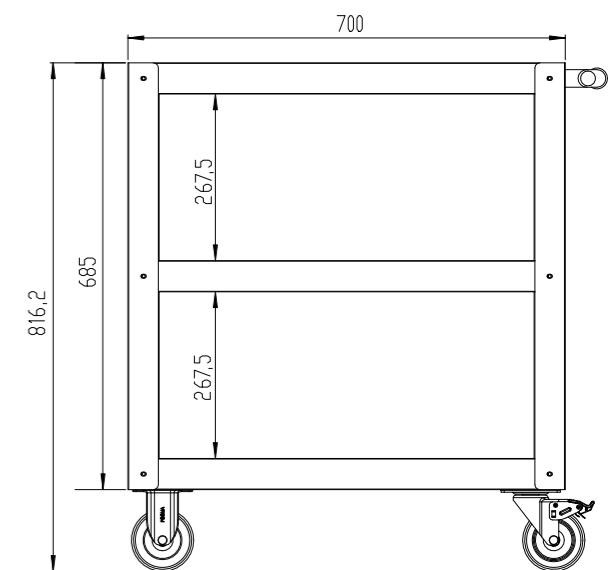
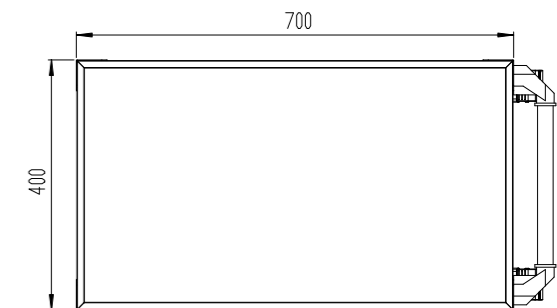

Model: JOE



JOE tool cart is equipped with 6 capacious drawers, so that the most necessary tools are always at your fingertips. Additional storage options are provided by perforated boards placed on the sides. Durable and maneuverable casters allow convenient movement on any surface. A sturdy lock secures stored items from unauthorized access.

Description

Size:	995x680x460 mm	Certificate:	PZH
Table weight:	48 kg	Load capacity of drawers:	40 kg
Material:	powder coated steel	Package dimensions:	92x75x53,5 cm
Steel thickness:	0,8 mm	Distance between holes in perforated board:	27 mm
Maximum load:	327 kg		

Colours:



For which rooms:

 Automotive workshops

 Craft workshops

 Backyard workshops









 Garages

Advantages of JOE tool cart:

- Made of sturdy 0.8 mm thick steel with powder-coated paint. This makes it resistant to corrosion and mechanical damage, as well as easy to clean;
- Includes 6 capacious drawers of two sizes - the top 3 are shallow and suitable for storing small tools. The lower ones have increased depth with larger items in mind;
- Wide handles on the drawer fronts and sturdy slides allow easy opening and quick access to tools;
- A practical lock allows you to secure access to all drawers with a single turn of the key. Two keys included;
- Perforated boards located on the sides offer additional storage space. With the help of handles (not included), you can hang your most frequently used tools on them to keep them close at hand at all times;
- The interiors of the drawers and the top of the cart contain protective mats that insulate the tools from the metal base, preventing scratching and noise during movement;
- Easy movement on any surface is possible thanks to a convenient handle and maneuverable rubber wheels that won't damage the floor.



Main features:

-  6 drawers
-  1 lock for all drawers
-  Perforated side panels
-  Powder-coated steel
-  Large casters with brakes
-  Handle for easy movement
-  Protective mats
-  6 year warranty

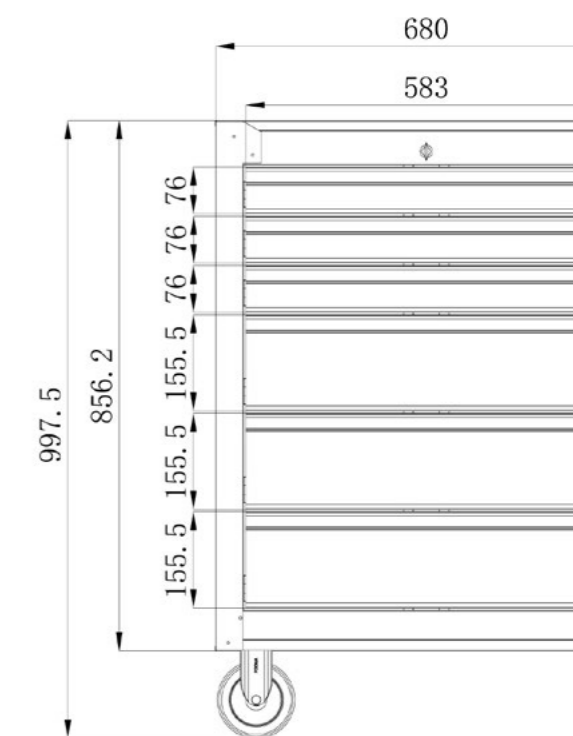

Model: LEO

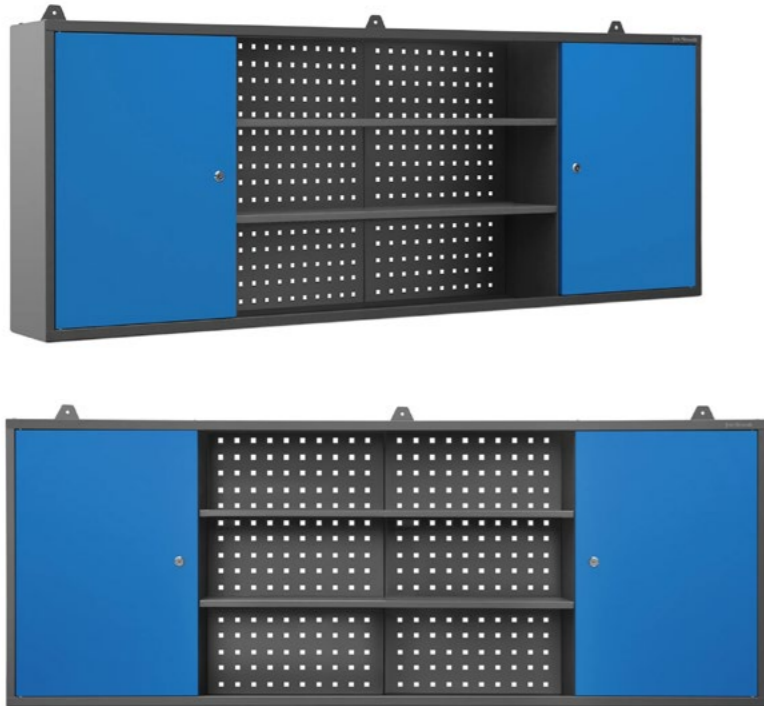

LEO hanging workshop cabinet has perfectly matched dimensions: large width (up to 160 cm), optimal height (60 cm) and small depth (20 cm). This makes it perfect for narrow rooms or for hanging over a workbench. It has three separate zones, two of which are lockable. An additional convenience is the perforated board located at the back, which allows you to hang tools conveniently. LEO cabinet is a proven solution for both plants, factories and private spaces - garages, home workshops.

Description

Size:	1600x600x200 mm	Distance between holes of perforated board:	10 mm
Weight of the cabinet:	21 kg	Perforated board hole diameter:	5x5 mm
Material:	Powder coated steel	Maximum load:	40 kg
Steel thickness:	0,8 mm		
Package dimensions:	167,5x48,5x6,5 cm		

Colours:

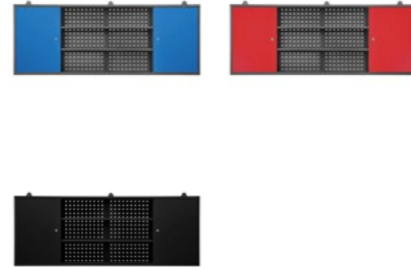

For which rooms:

 Craft workshops, vulcanization plants

 Construction companies

 Automotive workshops







 Backyard workshops

 Garages

Advantages of LEO hanging workshop cabinet:

- Division into three storage zones - two lockable cabinets and one, large open niche. This is a proven way to store tools conveniently;
- Lockable cabinets allow you to assign access to the interior only to selected people. This is a good place to store more valuable tools or documents;
- A large alcove with easy-access shelves will hold a lot of items that are always within reach;
- The perforated board located along the entire length of the cabinet will allow great management of the interior of the cabinet. This will avoid clutter and provide easy access to all items;
- Powder-coated steel components are well protected against damage and rust. The even coating of the varnish and well-chosen colors significantly affect the aesthetics of the cabinet and create a matching set of workshop furniture;
- The load capacity of the cabinet is up to 40 kg, but when loading the furniture, take into account the method of installation and the strength of the wall;
- Thoughtful dimensions. The cabinet is wide (as much as 160 cm), but it is only 20 cm deep, so it will accommodate a lot of items and at the same time will not impede movement in narrow spaces.
- For excellent stability, the LEO cabinet has as many as three hooks for attaching to the wall;
- Intuitive and quick installation.

Main features:

-  Three storage zones
-  2 lockable cabinets.
-  Spacious recess with two shelves
-  Tool board
-  Powder-coated steel
-  Large cabinet width
-  6-year warranty

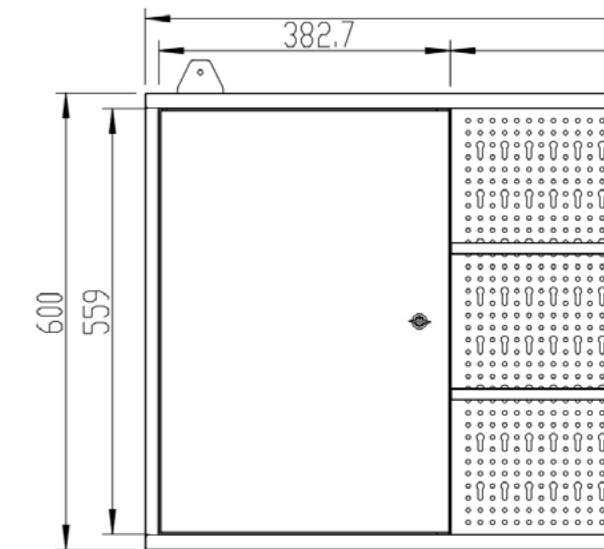
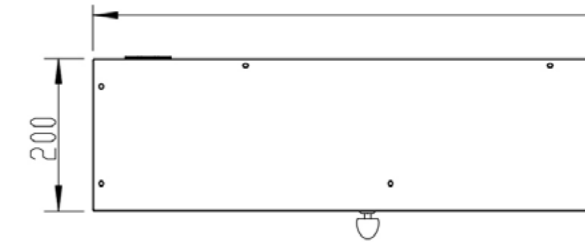

Model: LOGAN



LOGAN workbench is a professional piece of furniture that provides an ergonomic and comfortable place to work. The massive steel frame and adjustable legs make the spacious 150 x 75 cm tabletop fully stable. A large tool board located on the lamp rack allows great organization and storage of all necessary accessories and tools close to the workstation. Lockable drawers are suitable for storing valuable items or documents. An outlet located in the rack will allow you to conveniently plug in electronic equipment.

Description

Size:	1500x800x750 mm	Distance between holes in perforated board:	27 mm
Table weight:	86 kg	Dimensions of perforated board holes:	10x10 mm
Material:	Powder coated steel	Maximum load:	600 kg
Steel thickness:	1,5/1,0/0,8 mm	Permissible drawer load:	45 kg
Package dimensions:	62x57,5x40,5 cm 158,5x84x16 cm 143,5x49,5x5 cm		

Colours:



For which rooms:

 Craft workshops, vulcanization plants

 Construction companies

 Automotive workshops

 Backyard workshops

 Garages

Advantages of LOGAN workbench:

- Adjustable legs give you a stable and level table top. Essential functionality especially in case of uneven floors;
- Satisfying work surface of 150 x 75 cm. Enlarged depth influences the comfort of performed duties even with hung ergo boxes. The tabletop is made of sturdy 3 mm thick MDF board;
- Powder-coated steel components are well protected against damage and rust. The even coating of varnish and well-chosen colors significantly affect the aesthetics of the workbench;
- The upper frame allows you to install lighting. It is adjustable, so you can adjust it to the work being done. The workbench does not include a lamp in the set;
- Two, spacious drawers with a key lock with a load capacity of 45 kg each. In addition, they have convenient handles that make it easy to open the drawers with gloves;
- The workbench has two perforated boards. The lower one is designed for mounting organizers for small items such as screws, while the upper one is suitable for hanging tools;
- The shape of the workbench, which resembles a classic desk, allows you to work comfortably in a sitting position;
- Electronic tools can be conveniently connected to electricity thanks to an outlet built into the frame.

Main features:

-  2 lockable drawers.
-  Tool board
-  Lamp rack
-  Sturdy MDF top
-  Adjustable legs
-  Solid, sturdy frame
-  Built-in European type socket
-  Powder-coated steel
-  6-year warranty

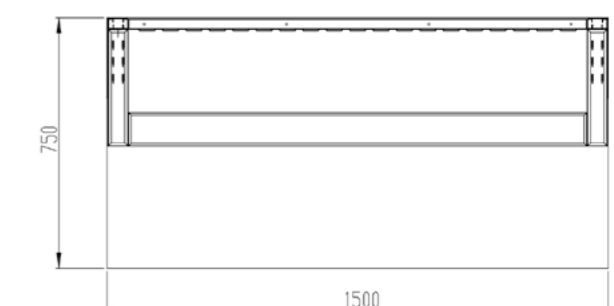
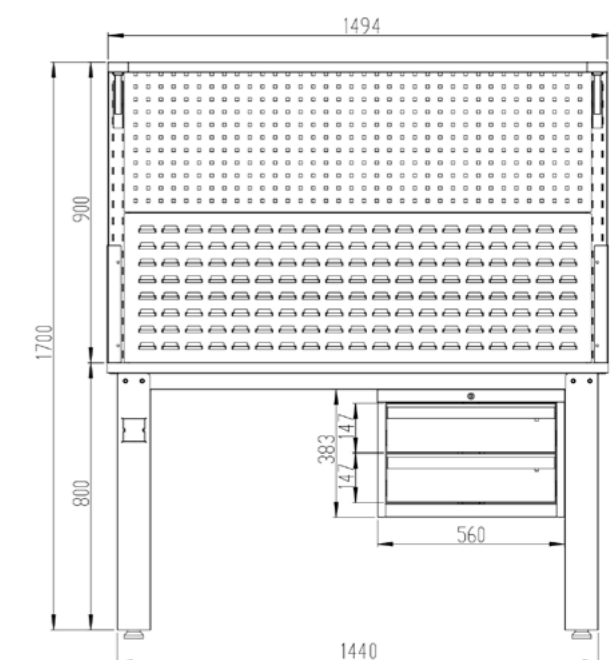

Model: MARIUSZ



The mobile workshop wall MARIUSZ consists of a stable frame with six perforated metal panels. Tools can be arranged on both sides of the sturdy panels. The platform on wheels provides high mobility, so you can always have the most necessary tools at your fingertips. It will be ideal for a professional factory or workshop. It will also more than meet the expectations of the home DIYer.

Description

Size:	1555x965x610 mm	Distance between holes in perforated board:	27 mm
Wall weight:	51 kg	Dimensions of perforated board holes:	10x10 mm
Material:	powder coated steel	Diameter of casters:	10, 16 cm
Steel thickness:	1,6/1,3 mm	Certificate:	PZH
Package dimensions:	104,5x70,5x19 cm 152,5x34,5x11 cm		

Colours:



For which rooms:

 Automotive workshops

 Craft workshops







 Backyard workshops, garages

Advantages of the workshop wall MARIUSZ:

- The boards are covered with powder paint, which provides high resistance to corrosion and mechanical damage. It also makes the tools clearly visible on it;
- The wall consists of six panels. Four perforated panels are ideal for hanging wrenches, hammers or screwdrivers. Two more have hooks for attaching ergoboxes that can hold small items - screws, nails or gaskets;
- The arrangement of the boards, as well as the positioning of the tools, can be changed at will, adjusting the storage space to suit your own work ergonomics;
- Large and maneuverable wheels, as well as a convenient handle on the side of the board, make it easy to move the workbench wall. As a result, the most necessary tools are always at your fingertips;
- Two casters are equipped with brakes that will immobilize the workbench wall, ensuring safety during work;
- The sturdy base is made of 1.6 mm sheet metal. The 1.3 mm thick boards have 10 mm square holes spaced every 27 mm. This allows the use of handles supported by two hooks, which makes installation easier and ensures high stability.



Main features:

-  Panels on two sides of the wall.
-  2 types of panels for tools and ergo-boxes
-  Powder-coated steel
-  Large casters with brakes
-  Handle for easy movement
-  6 year warranty

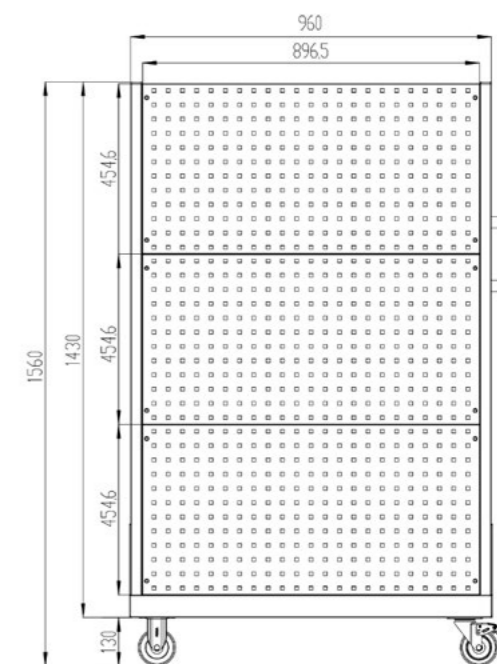
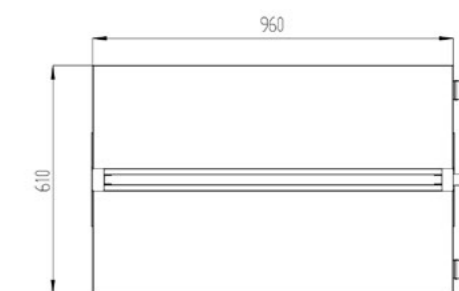

Model: PAULA

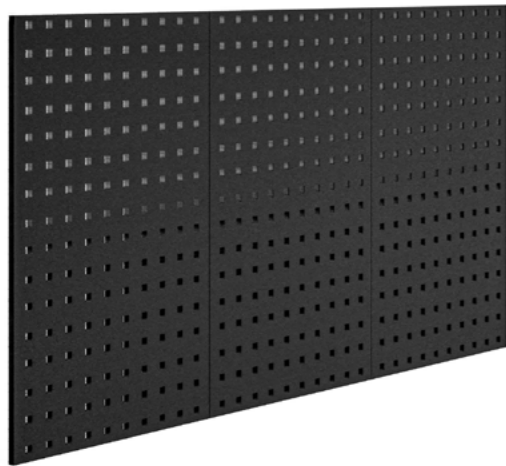

Colours:

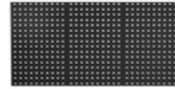

The PAULA tool board consists of three independent powder-coated metal panels that create a convenient 120 x 60 cm storage space. The damage-resistant 0.8 mm thick board does not take up much space, making it ideal for both larger and smaller workshops. Evenly distributed holes allow you to organize your tools according to your preferences.

Description

Size: 600x1200x10 mm

Wall weight: 4,5 kg

Material: powder coated steel

Steel thickness: 0,8 mm

Package dimensions:
194x109x10 cm
84,5x50x28 cm
84x50x44,5 cm

Distance between holes in perforated board: 27 mm

Dimensions of perforated board holes: 10x10 mm

For which rooms:

 Automotive workshops

 Craft workshops

 Backyard workshops, garages

Zalety ścianki PAULA:

- PAULA board consists of three independent perforated panels that create an accessible handy space of 120 x 60 cm;
- In smaller spaces, the board can be separated into three independent modules for tools, improving ergonomics;
- Made of 0.8 mm thick metal components, it does not take up much space and is resistant to corrosion, mechanical damage and scratches;
- The board is covered with an aesthetically pleasing powder coating, which not only looks elegant, but also makes the tools clearly visible on it;
- The 10 x 10 mm square holes are spaced evenly every 27 mm, allowing you to arrange the tools according to your preferences;
- Thoughtful design provides easy and convenient access to your favorite tools, making it suitable for the hobbyist DIYer and professional alike;
- Simple and quick installation with 12 pegs attached to the wall.

Main features:

- Three separate panels
- 12 mounting studs
- Powder-coated steel
- 6-year warranty

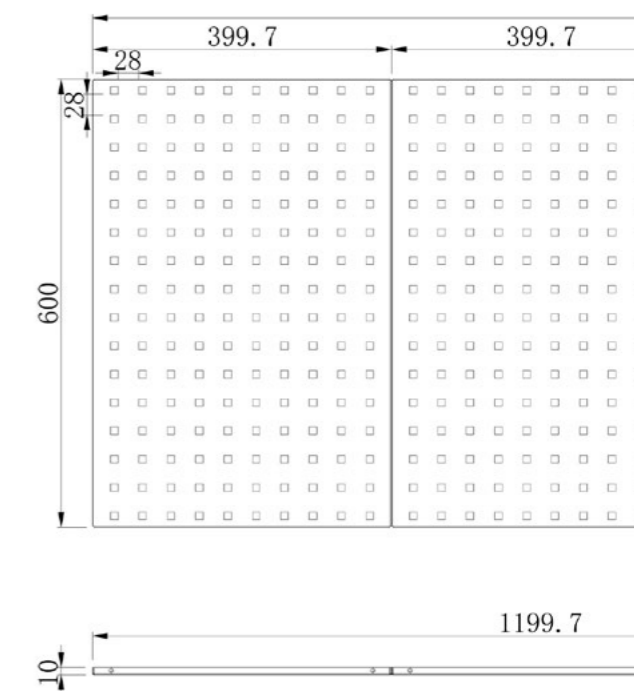

Model: SAM



SAM metal garage shelving is a proven and convenient way to store items or tools. Sturdy metal shelves placed on a reinforced frame provide a high load capacity of up to 85 kg. The rack frame offers a convenient change of the shelves' height every 38 mm. The SAM garage shelving is also distinguished by convenient assembly without screwing. It is ideal for workshops or warehouses, making the necessary items always in view.

Description

Size:	1830x900x450 mm	Package dimensions:	100x58x12,5 cm
Total weight:	26 kg	Shelf load capacity:	85 kg
Material:	powder coated steel		
Steel thickness:	1,0/0,6 mm		

Colours:



For which rooms:

 Automotive workshops





 Craft workshops

 Backyard workshops, garages

Advantages of SAM garage shelving:

- All elements of SAM metal garage shelving are coated with powder paint, which provides protection against corrosion or mechanical damage and is easy to clean;
- The garage shelving is made of sturdy 1 mm thick sheet metal. Its supports contain two layers, so that only the inner one has perforations for attaching shelves, which affects the stability and appearance of the rack;
- It comes with 5 sturdy metal shelves with a thickness of 0.6 mm and a maximum load capacity of 85 kg, so you can place a lot of items on them;
- The ability to adjust the height of the shelves in 38 mm increments provides space for large items as well;
- Easy assembly without twisting or additional tools. The double-riveted shelf brackets connect to the frame by pressing;
- All necessary components are included - feet, caps, connecting parts and clear instructions.

Main features:

-  5 shelves with a load capacity of 85 kg.
-  Height adjustment of shelves
-  Powder-coated steel
-  Construction that does not require screwing down
-  6-year warranty

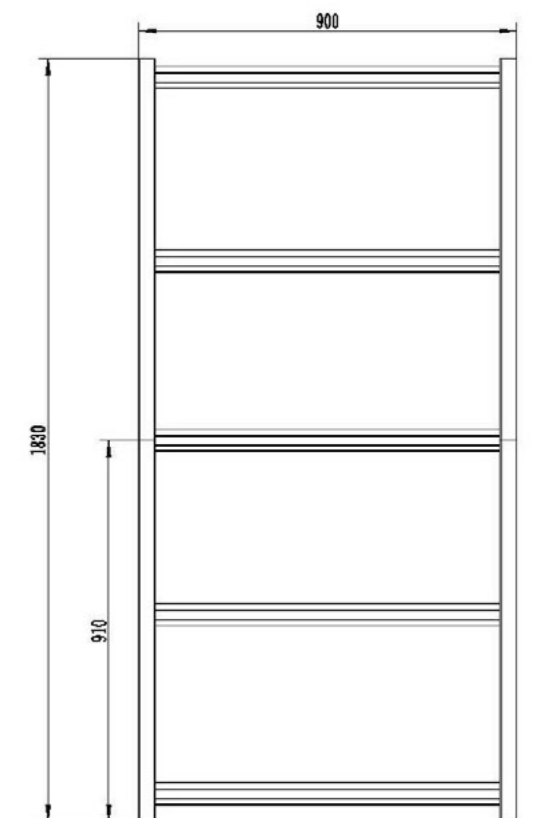
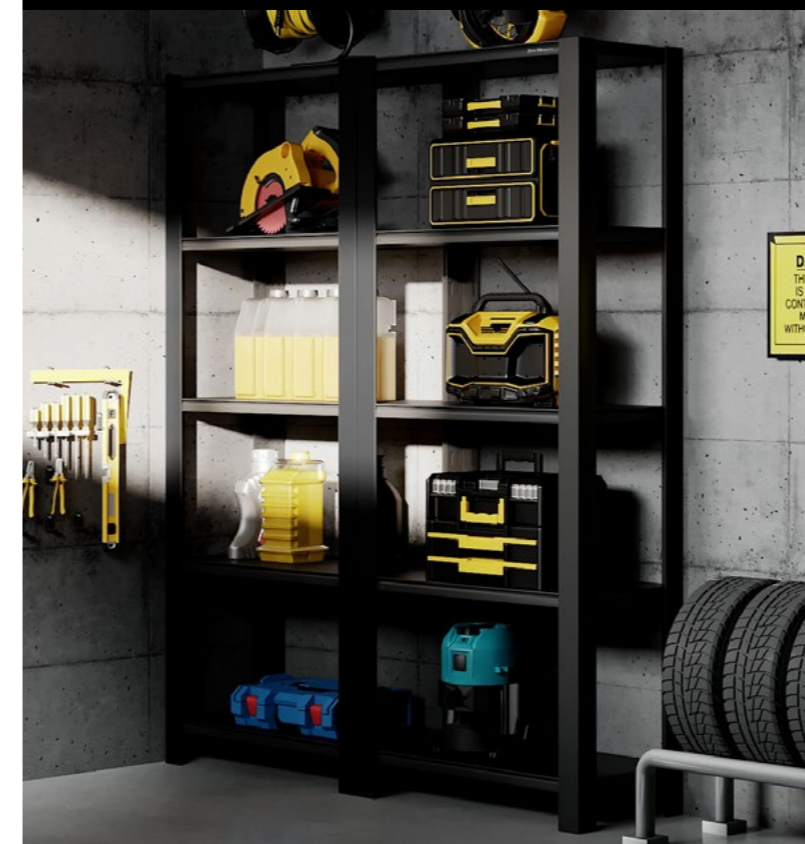

Model: STEVE



Colours:



The STEVE computer cabinet allows you to place your computer as close as possible to your employees without worrying about damaging expensive equipment. Separated three functional zones (for monitor, mouse and keyboard, and CPU) locked with a key will allow you to easily manage access to each of them. The cabinet protects your computer from overheating, as it has vents and a dedicated place to mount a fan.

Description

Size:	640x1750x630 mm	Dimensions of the hole for the fan:	124x124 mm
Cabinet weight:	62 kg	Shelf load capacity:	70 kg
Material:	powder coated steel	Package dimensions:	182,5x72,5x20 cm
Steel thickness:	0,6/0,8 mm		

For which rooms:



Craft workshops



Vulcanization plants



Construction companies



Automotive workshops



Warehouses

Advantages of STEVE computer cabinet:

- Comfortable use of the computer screen - the area for the monitor protected by a door with tempered glass. This is a durable solution that, compared to plexiglass counterparts, does not scratch easily and maintains excellent condition for a long time;
- Excellent ventilation - side vents and a dedicated fan opening guarantee free airflow and prevent equipment from overheating. The kit does not include a fan;
- Easy cable organization - the bottom of the computer cabinet accommodates a cable exit hole. One dedicated place for all cables prevents dust and dirt from getting inside;
- Reliable security - the computer's central processing unit is protected by a reinforced door and a solid lock locked at three points;
- Practical division into 3 zones - each level is locked with a separate key. This way the employee will have access only to the mouse and keyboard, and the IT administrator to all the equipment. Every lock contains two keys;
- Perfect leveling - adjustable feet allow you to set the cabinet straight even if the floor is uneven;
- Interior to match the equipment - additional shelves with height adjustment in 25 mm increments.

Main features:

- ≡ 3 separately lockable zones.
- ↑↓ 2 adjustable shelves
- 🌀 Ventilation openings
- 🔒 Tempered glass doors.
- 🔲 Powder-coated steel
- 🦿 Adjustable feet
- 🛡️ 6-year warranty

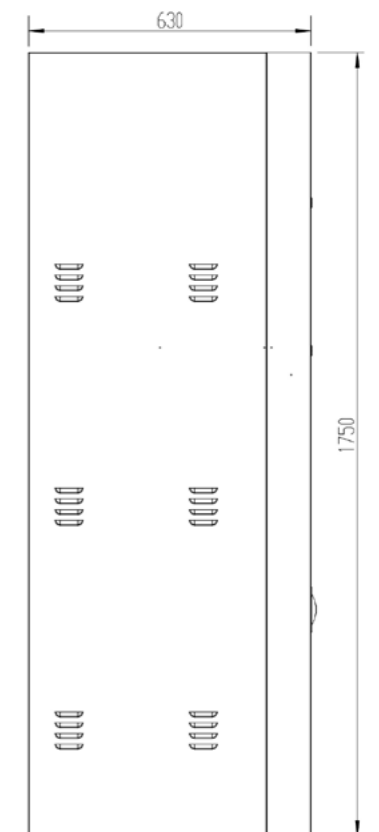

Model: SZYMON



Colours:



Workshop cabinet SZYMON combines the convenience of storing tools in drawers with sufficiently large space for larger items. Inside the cabinet and on the inside of the door there are two types of perforated boards. The upper ones allow the installation of tool holders and hooks, while those below are designed for hanging ergo box containers. In addition, the cabinet is equipped with two large drawers. Thanks to well-thought-out conveniences, keeping order in the SZYMON cabinet is extremely easy, and finding the needed item takes very little time.

Description

Size:	1850x920x500 mm	Distance between holes in perforated board:	27 mm
Cabinet weight:	120 kg	Dimensions of perforated board holes:	10x10 mm
Material:	Powder coated steel	Shelf load capacity:	80 kg
Steel thickness:	1,1 mm	Drawer load capacity:	40 kg
Package dimensions:	194x110x10 cm 85x50,5x19 cm	Certificate:	PZH

For which rooms:



Automotive workshops, manufacturing plants, warehouses



Craft workshops, construction companies



Household workshops, garages



Fire department premises



Police stations and police headquarters, municipal police stations

Advantages of SZYMON cabinet:

- The structure of the cabinet is stable and resistant to damage, because it was made of powder-coated steel sheet 1,1 mm thick;
- The capacious interior of the closet conceals two drawers and two niches. Thanks to the shelves, which are adjustable every 25 mm, you can adjust its interior to your individual needs;
- The spacious recess at the bottom is great for storing large and heavy items, as it is definitely easier to reach for them;
- The design with a special perforation at the top of the cabinet makes it perfect for introducing a convenient and well-organized space for small items such as screws, nuts, screwdrivers, keys;
- Two drawers located at hand height allow quick and convenient access to the tools stored in them. Thanks to the high-quality slides, they are extremely quiet and can carry up to 40 kg;
- All items inside are properly secured, as the cabinet has a 3-point locking mechanism. The strong door and 3-point lock prevent unauthorized people from opening the closet door;
- The assembly of the cabinet is quick and intuitive.

Main features:



Robust and stable construction



2 capacious drawers



2 types of perforations for great organization of items



2 sturdy shelves



Shelf adjustment every 25 mm



3-point lock to secure contents



Powder coated steel



6 year warranty

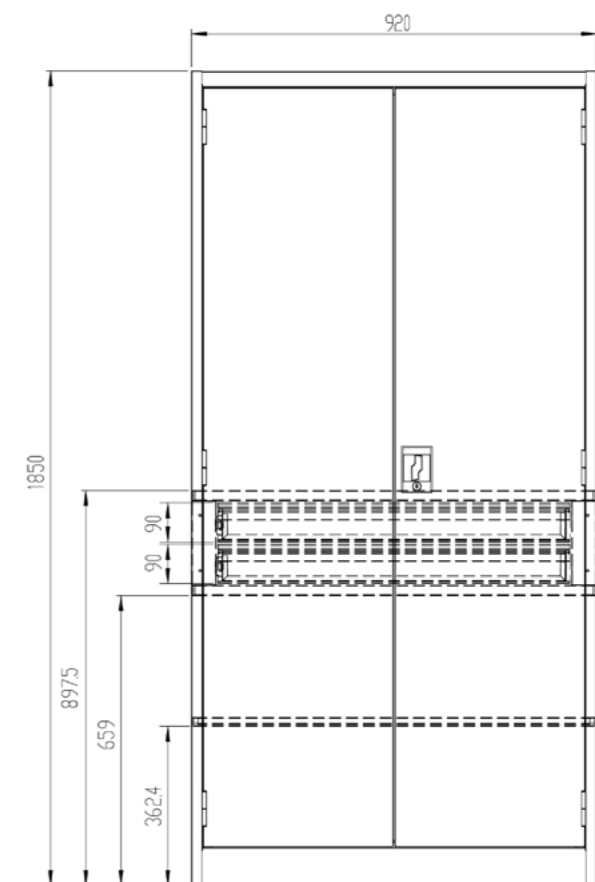

INDEX TABLE

Office furniture:

MODEL	COLOUR	SKU	EAN
ALEX	ANTHRACITE/WALNUT	1382	5904405570470
ALEX	BEIGE	1499	5904405576236
ALEX	WHITE	1029	5902560335453
ALEX	WHITE/OAK SONOMA	1381	5904405570463
ALEX	PINK	1497	5904405576212
ALEX	GREY	1028	5902560335446
ALEX	GREEN	1498	5904405576229
AMELIA	BEIGE	1553	5904405577318
AMELIA	WHITE	606	5902560331592
AMELIA	PINK	1555	5904405577332
AMELIA	GREY	48	5902560331622
AMELIA	GREEN	1554	5904405577325
BEATA	ANTHRACITE	976	5902560334883
BEATA	ANTHRACITE/WHITE	787	5902560334128
BEATA	ANTHRACITE/RED	943	5902560334814
BEATA	ANTHRACITE/BLUE	936	5902560334555
BEATA	ANTHRACITE/WALNUT	1378	5904405570432
BEATA	BEIGE	1505	5904405576298
BEATA	WHITE	975	5902560334876
BEATA	WHITE/OAK SONOMA	1377	5904405570425
BEATA	BLACK	1061	5902560337587
BEATA	GREY	41	5902560331783
BEATA	GREY/BLUE	40	5902560330649
BEATA	PINK	1503	5904405576274
BEATA	GREEN	1504	5904405576281
DAMIAN	ANTHRACITE	996	5902560335163
DAMIAN	ANTHRACITE/WHITE	750	5902560332704
DAMIAN	ANTHRACITE/RED	759	5902560332766
DAMIAN	WHITE	751	5902560332681
DAMIAN	WHITE/GREY	918	5902560332698
DAMIAN	GREY	984	5902560335019
DANIEL	ANTHRACITE	988	5902560335088
DANIEL	ANTHRACITE/WHITE	785	5902560336276
DANIEL	WHITE	986	5902560336818
DANIEL	GREY	614	5902560336856
EDMUND	GREY	51	5902560331332
EWA	ANTHRACITE	1152	5902560338478
EWA	ANTHRACITE/WHITE	1132	5902560338379
EWA	GREY	1131	5902560338362
FILIP	ANTHRACITE	802	5902560334074
FILIP	ANTHRACITE/WHITE	992	5902560335125
FILIP	WHITE	991	5902560335118
FILIP	GREY	616	5902560331257
FILIP II	ANTHRACITE	1027	5902560335415
FILIP II	ANTHRACITE/WHITE	1025	5902560335392

FILIP II	BLACK	1060	5902560337570
FILIP II	GREY	1024	5902560335385
JAN	ANTHRACITE	799	5902560333602
JAN	ANTHRACITE/WHITE	619	5902560330991
JAN	ANTHRACITE/RED	758	5902560332735
JAN	ANTHRACITE/BLUE	811	5902560334135
JAN	ANTHRACITE/WALNUT	1334	5902560334982
JAN	BEIGE	1493	5904405576175
JAN	WHITE	592	5902560331004
JAN	WHITE/OAK SONOMA	1333	5902560332346
JAN	BLACK	1058	5902560337549
JAN	PINK	1491	5904405576151
JAN	GREY	46	5902560330977
JAN	GREY-BLUE	47	5902560330984
JAN	GREEN	1492	5904405576168
JAN H	ANTHRACITE	911	5902560333671
JAN H	ANTHRACITE/WHITE	788	5902560333688
JAN H	ANTHRACITE/RED	806	5902560334166
JAN H	ANTHRACITE/BLUE	812	5902560334142
JAN H	ANTHRACITE/WALNUT	1336	5902560333558
JAN H	BEIGE	1496	5904405576205
JAN H	WHITE	962	5902560334838
JAN H	WHITE/OAK SONOMA	1335	5902560333565
JAN H	BLACK	1059	5902560337563
JAN H	PINK	1494	5904405576182
JAN H	GREY	43	5902560331059
JAN H	GREY-BLUE	42	5902560331042
JAN H	GREEN	1495	5904405576199
JAN II	ANTHRACITE	1009	5902560335293
JAN II	ANTHRACITE/WHITE	1005	5902560335255
JAN II	ANTHRACITE/RED	1008	5902560335286
JAN II	ANTHRACITE/BLUE	1007	5902560335279
JAN II	WHITE	1004	5902560335248
JAN II	GREY	1003	5902560335231
JAN II	GREY/BLUE	1006	5902560335262
KEVIN	ANTHRACITE/WHITE	1037	5902560335538
KEVIN	ANTHRACITE/WALNUT	1386	5904405570517
KEVIN	WHITE/OAK SONOMA	1385	5904405570500
KEVIN	GREY	1035	5902560335514
KUBA	ANTHRACITE/WHITE	915	5902560333398
KUBA	ANTHRACITE/WALNUT	1384	5904405570494
KUBA	WHITE	773	5902560333381
KUBA	WHITE/OAK SONOMA	1383	5904405570487
KUBA	GREY	774	5902560333374
LENA	GREY	1109	5902560338089
MAGDA	GREY	798	5902560333961
SARA V3	WHITE	1021	5902560335675

SARA V4	ANTHRACITE/WALNUT	1388	5904405570531
SARA V4	WHITE	977	5902560336795
SARA V4	WHITE/OAK SONOMA	1387	5904405570524
SARA V4	GREY	810	5902560336252
SARA V4	GREY/BLUE	1011	5902560335026
SARA V5	ANTHRACITE/WHITE	1013	5902560336801
SARA V5	ANTHRACITE/WALNUT	1380	5904405570456
SARA V5	WHITE	983	5902560335040
SARA V5	WHITE/OAK SONOMA	1379	5904405570449
SARA V5	GREY	982	5902560335033

Social furniture:

MODEL	COLOUR	SKU	EAN
BARTEK	ANTHRACITE/WHITE	979	5902560334975
BARTEK	ANTHRACITE/RED	978	5902560334968
BARTEK	ANTHRACITE/WALNUT	1342	5902560332308
BARTEK	WHITE/OAK SONOMA	1341	5902560332315
BARTEK	MULTICOLOUR	1093	5902560337914
BARTEK	GREY	779	5902560334005
BARTEK	GREY/BLUE	944	5902560334777
BARTUŚ	MULTICOLOUR	1094	5902560337921
BARTUŚ	MULTICOLOUR PASTEL	1490	5904405576144
BORYS	ANTHRACITE	998	5902560336832
BORYS	ANTHRACITE/WHITE	999	5902560337235
BORYS	GREY	796	5902560333985
DAWID	ANTHRACITE	1374	5904405570258
DAWID	BEIGE	1502	5904405576267
DAWID	BLACK	1532	5904405577141
DAWID	PINK	1500	5904405576243
DAWID	GREY	1103	5902560338027
DAWID	GREEN	1501	5904405576250
IGOR	ANTHRACITE/WHITE	945	5902560333824
IGOR	ANTHRACITE/RED	781	5902560333831
IGOR	ANTHRACITE/FUKSJA	809	5902560334340
IGOR	ANTHRACITE/WALNUT	1344	5902560331066
IGOR	WHITE/OAK SONOMA	1343	5902560332292
IGOR	MULTICOLOUR	1096	5902560337945
IGOR	GREY	780	5902560333817
IGOR	GREY/BLUE	946	5902560334784
IGOREK	MULTICOLOUR	1097	5902560337952
JULIA	ANTHRACITE	1484	5904405574980

TOMASZ	ANTHRACITE	994	5902560335149
TOMASZ	WHITE	993	5902560337211
TOMASZ	GREY	610	5902560337198
WIOLA	ANTHRACITE	1001	5902560335217
WIOLA	ANTHRACITE/WHITE	1002	5902560335224

JULIA	ANTHRACITE/WHITE	1485	5904405574997
JULIA	ANTHRACITE/WALNUT	1486	5904405575000
JULIA	GREY	1105	5902560338041
KACPER	ANTHRACITE/WHITE	940	5902560334715
KACPER	ANTHRACITE/RED	941	5902560334760
KACPER	ANTHRACITE/BLUE	942	5902560334708
KACPER	ANTHRACITE/WALNUT	1340	5902560332322
KACPER	WHITE/OAK SONOMA	1339	5902560332339
KACPER	GREY	530	5902560332506
KACPER	GREY/BLUE	529	5902560332490
KACPER II	GREY	608	5902560330625
KACPER II	GREY/BLUE	609	5902560330618
KACPER II PRO	GREY/ANTHRACITE	1540	5904405577240
KAROL	ANTHRACITE/WHITE	960	5902560333879
KAROL	ANTHRACITE/RED	981	5902560334999
KAROL	GREY	783	5902560333855
KAROL	GREY/BLUE	959	5902560334821
MARCIN	ANTHRACITE/WHITE	948	5902560334807
MARCIN	ANTHRACITE/RED	980	5902560335606
MARCIN	GREY	782	5902560333848
MARCIN	GREY/BLUE	947	5902560334791
OLA	MULTICOLOUR	1110	5902560338096
OLA	MULTICOLOUR PASTEL	1489	5904405576137
OLIVER	GREY	1107	5902560338065
ROBERT	ANTHRACITE	1482	5904405574959
ROBERT	ANTHRACITE/WHITE	1481	5904405574966
ROBERT	ANTHRACITE/WALNUT	1483	5904405574973
ROBERT	GREY	1104	5902560338034



Domator24 | Jan Nowak

ul. Dekoracyjna 8

65-155 Zielona Góra

www.jannowak.com